

**ANSI/ASME
B73.1
Dimensions**

FYBROC[®] SERIES 1530 CLOSE-COUPLED HORIZONTAL PUMPS

Corrosion Resistant FRP

Fiberglass Reinforced

- ✓ VR-1, Vinyl Ester Resin
- ✓ VR-1 BPO-DMA, Vinyl Ester Resin with BPO-DMA Cure System
- ✓ VR-1A, Vinyl Ester Resin with Abrasive Resistant Material
- ✓ VR-1V, Vinyl Ester Resin with Synthetic Veil
- ✓ EY-2, Epoxy Resin

16 Sizes

- ✓ Flows to 1500 GPM (345 m³/hr)
- ✓ Heads to 400 ft (125 m)
- ✓ C-faced JM Extension Motors up to 50 HP (37 kW)

Lightweight & Space Efficient

- ✓ Ideal for OEM Applications

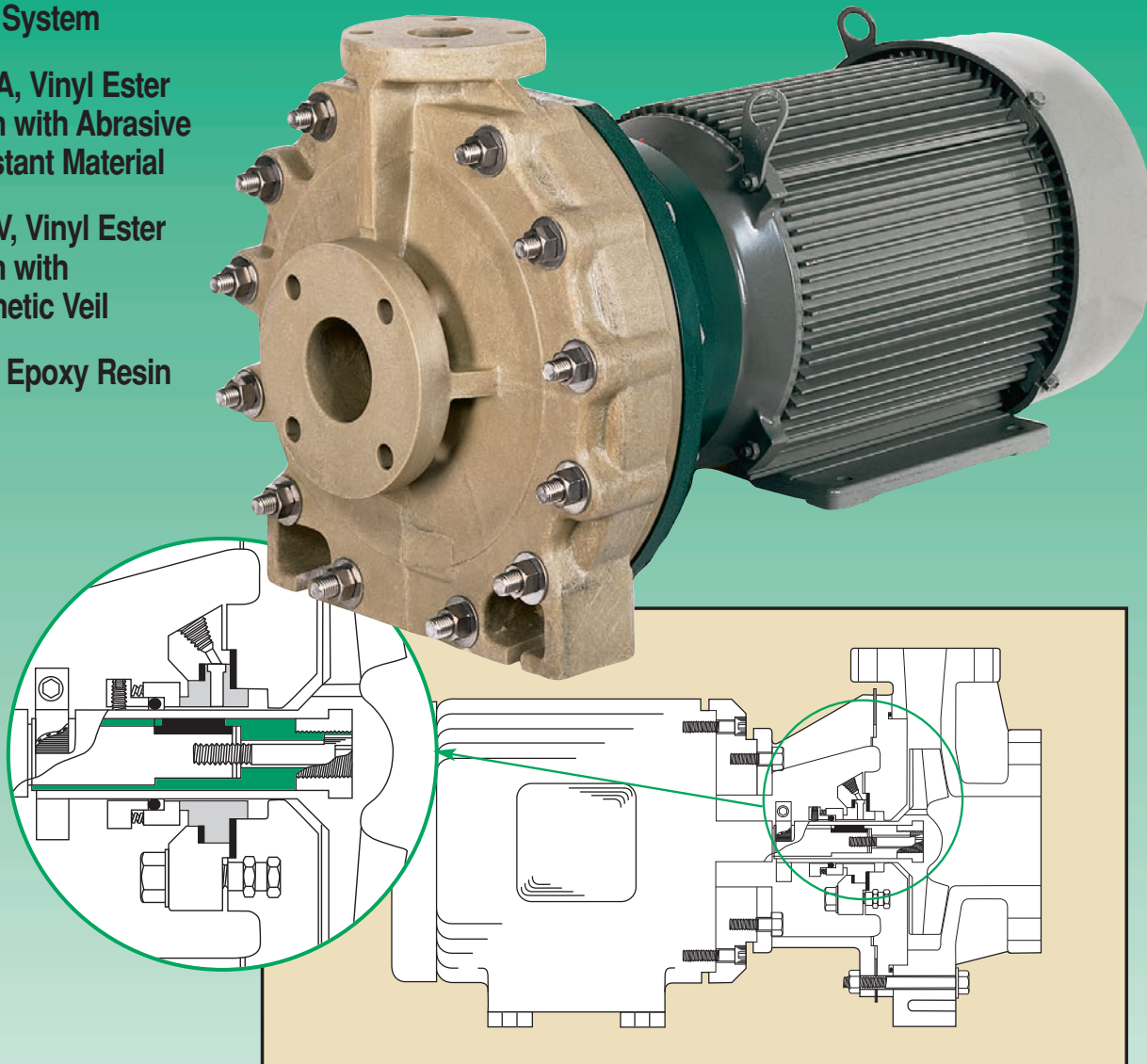

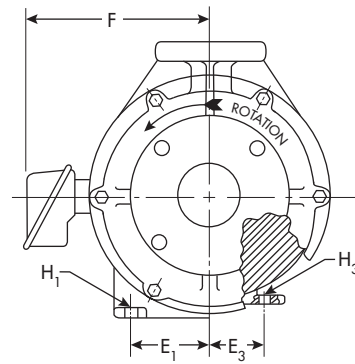
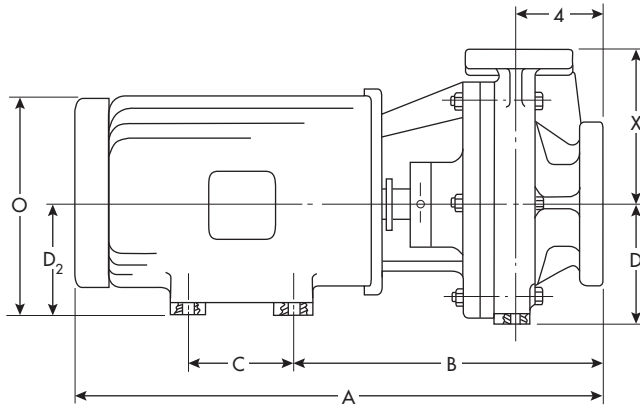

	GROUP I				GROUP II											
PUMP SIZE	1x1 ¹ / ₂ x6	1 ¹ / ₂ x3x6	2x3x6	1x1 ¹ / ₂ x8	1 ¹ / ₂ x3x8	2x3x8	3x4x8	1x2x10	1 ¹ / ₂ x3x10	2x3x10	3x4x10	4x4x10	4x6x10	2x3x3	3x4x13	4x6x13
Suction	1 ¹ / ₂	3	3	1 ¹ / ₂	3	3	4	2	3	3	4	4	6	3	4	6
Discharge	1	1 ¹ / ₂	2	1	1 ¹ / ₂	2	3	1	1 ¹ / ₂	2	3	4	4	2	3	4
X	6 ¹ / ₂	6 ¹ / ₂	6 ¹ / ₂	6 ¹ / ₂	8 ¹ / ₂	9 ¹ / ₂	11	8 ¹ / ₂	8 ¹ / ₂	9 ¹ / ₂	11	12 ¹ / ₂	13 ¹ / ₂	11 ¹ / ₂	12 ¹ / ₂	13 ¹ / ₂
D	5 ¹ / ₄	5 ¹ / ₄	5 ¹ / ₄	5 ¹ / ₄	8 ¹ / ₄	8 ¹ / ₄	8 ¹ / ₄	8 ¹ / ₄	8 ¹ / ₄	8 ¹ / ₄	8 ¹ / ₄	8 ¹ / ₄	10	10	10	10
E ₁	3	3	3	3	4 ⁷ / ₈	4 ⁷ / ₈	4 ⁷ / ₈	4 ⁷ / ₈	4 ⁷ / ₈	4 ⁷ / ₈	4 ⁷ / ₈	4 ⁷ / ₈	4 ⁷ / ₈	4 ⁷ / ₈	4 ⁷ / ₈	4 ⁷ / ₈
H ₁	5 ⁵ / ₈	5 ⁵ / ₈	5 ⁵ / ₈	5 ⁵ / ₈	5 ⁵ / ₈	5 ⁵ / ₈	5 ⁵ / ₈	5 ⁵ / ₈	5 ⁵ / ₈	5 ⁵ / ₈	5 ⁵ / ₈	5 ⁵ / ₈	5 ⁵ / ₈	5 ⁵ / ₈	5 ⁵ / ₈	5 ⁵ / ₈

Motor Frame	143 JM	145 JM	182 JM	184 JM	213 JM	215 JM	254 JM	256 JM	284 JM	286 JM	324 JM	326 JM
A* Group I Pump	20 ¹ / ₄	21 ¹ / ₄	22 ⁵ / ₈	23 ⁵ / ₈	25 ⁵ / ₈	26 ¹³ / ₁₆	28 ³ / ₈	30 ¹ / ₈	—	—	—	—
Group II Pump	21 ³ / ₄	22 ³ / ₄	24 ¹ / ₈	25 ¹ / ₈	26 ¹³ / ₁₆	28 ⁵ / ₁₆	29 ⁷ / ₈	31 ⁵ / ₈	31 ¹ / ₂	33	33 ¹ / ₂	35
B* Group I Pump	12 ¹¹ / ₁₆	12 ¹¹ / ₁₆	13 ⁷ / ₁₆	13 ⁷ / ₁₆	14 ⁵ / ₁₆	14 ⁵ / ₁₆	14 ¹³ / ₁₆	14 ¹³ / ₁₆	—	—	—	—
Group II Pump	14 ³ / ₁₆	14 ³ / ₁₆	14 ¹⁵ / ₁₆	14 ¹⁵ / ₁₆	15 ¹³ / ₁₆	15 ¹³ / ₁₆	16 ⁵ / ₁₆	16 ⁵ / ₁₆	16 ⁵ / ₁₆	16 ⁵ / ₁₆	16 ¹³ / ₁₆	16 ¹³ / ₁₆
C	4	5	4 ¹ / ₂	5 ¹ / ₂	5 ¹ / ₂	7	8 ¹ / ₂	10	9 ¹ / ₂	11	10 ¹ / ₂	12
D ₂	3 ¹ / ₂	3 ¹ / ₂	4 ¹ / ₂	4 ¹ / ₂	5 ¹ / ₄	5 ¹ / ₄	6 ¹ / ₄	6 ¹ / ₄	7	7	8	8
E ₃	2 ³ / ₄	2 ³ / ₄	3 ³ / ₄	3 ³ / ₄	4 ¹ / ₄	4 ¹ / ₄	5	5	5 ¹ / ₂	5 ¹ / ₂	6 ¹ / ₄	6 ¹ / ₄
H ₃	11 ¹ / ₃₂	11 ¹ / ₃₂	13 ¹ / ₃₂	13 ¹ / ₃₂	13 ¹ / ₃₂	13 ¹ / ₃₂	17 ¹ / ₃₂	17 ¹ / ₃₂	17 ¹ / ₃₂	17 ¹ / ₃₂	21 ¹ / ₃₂	21 ¹ / ₃₂
F*	6	6	7 ¹ / ₁₆	7 ¹ / ₁₆	8 ¹³ / ₁₆	8 ¹³ / ₁₆	10 ⁷ / ₁₆	10 ⁷ / ₁₆	11 ³ / ₈	11 ³ / ₈	13 ⁵ / ₁₆	13 ⁵ / ₁₆
O*	7 ¹ / ₈	7 ¹ / ₈	9 ³ / ₁₆	9 ³ / ₁₆	11 ¹ / ₄	11 ¹ / ₄	13 ¹ / ₂	13 ¹ / ₂	14 ⁵ / ₈	14 ⁵ / ₈	16 ¹¹ / ₁₆	16 ¹¹ / ₁₆

*DIMENSIONS BASED ON TEFC MOTOR DIMENSIONS - MAY VARY PER MANUFACTURER.

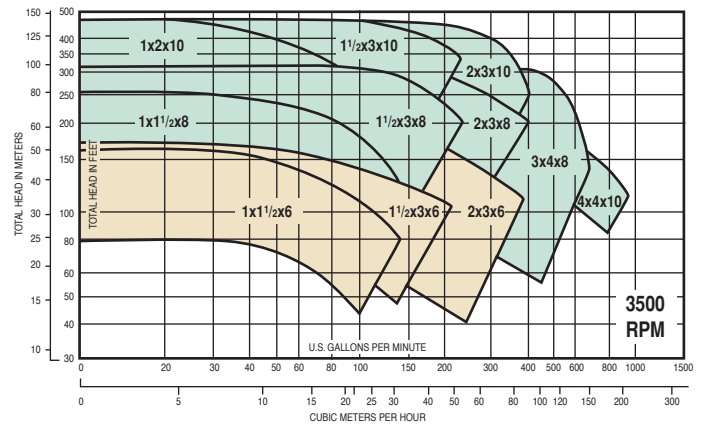
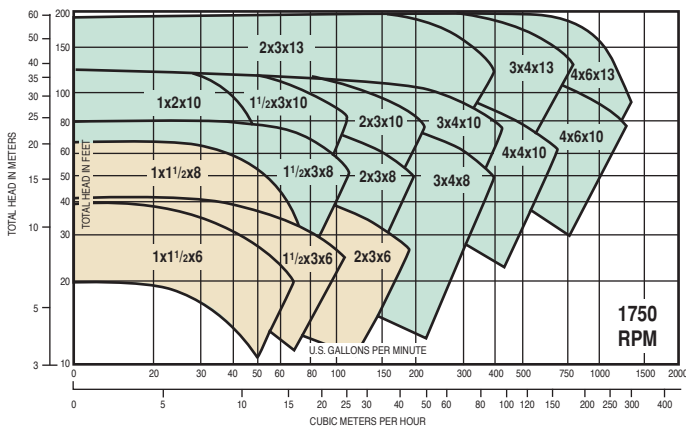

TAN AREAS INDICATE GROUP I PUMPS. GREEN AREAS INDICATE GROUP II PUMPS.



A Met-Pro Fluid Handling Technologies Business
Combining the Resources of Dean Pump, Fybroc & Sethco

700 Emlen Way • Telford, PA 18969
P: 215.723.8155 • TOLL-FREE: 800.FYBROC.1 • F: 215.723.2197
info@mp-gps.com • www.mp-gps.com



© 2012 MET-PRO CORPORATION
FYBROC® IS A REGISTERED TRADEMARK OF MET-PRO CORPORATION 07-5310 812

