

Enclosed Starters

Operation and Protection of Motors up to 600Hp at 460Vac (800A)

- Tough
- Reliable
- Durable
- Quality

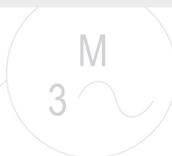
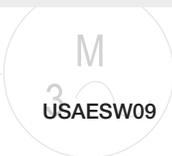
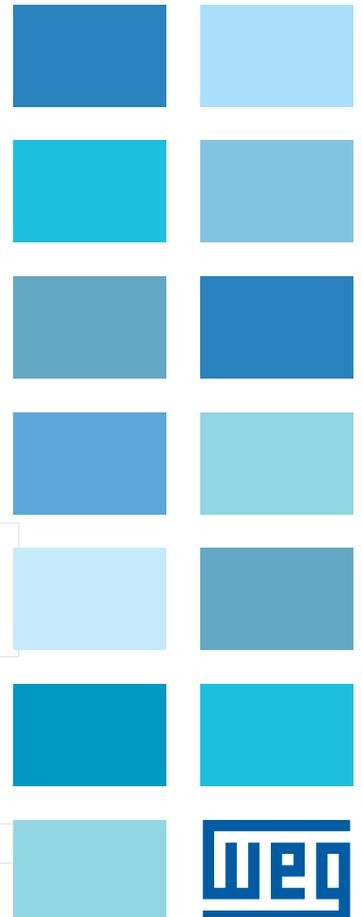
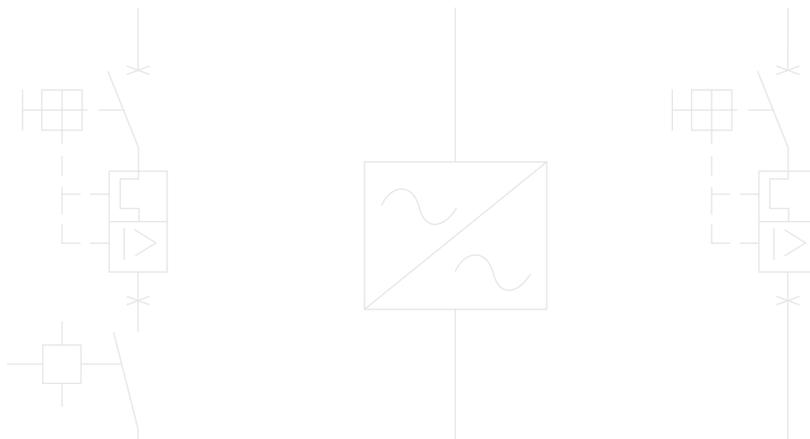

WEG enclosed starters series were designed to meet the requirements and flexibility frequently demanded in industrial applications. Featuring components that meet IEC design standards and UL horsepower ratings, WEG enclosed starters are UL508A approved and CSA certified. This means your panels will fulfill the rigorous requirements of UL508A and will have the quality and performance as for all WEG products

Standard or Custom

By having most of the processes in WEG facilities we can manufacture not only the enclosed starters listed on this catalog, but also any other custom panel your application may require. Our Engineers will work together with you to provide the perfect solution for your application.

Perfect Solution

WEG offers options for both: Full Voltage Non-Reversing Non-Combination Starters and Full Voltage Non-Reversing Combination Starters up to 250Hp at 460Vac.

WEG's UL508A panel shops can manufacture any configuration of Non-Combination or Combination Starters for any low voltage horsepower ratings. Some examples are listed below:

- Enclosed Contactors;
- Full Voltage Reversing Starters;
- Reduced Voltage Magnetic Starters (Part-

Winding, Wye-Delta);

- Reduced Voltage Solid-State Starters

(Softstarters, VFD);

- Multi-Speed Starters;
- Explosion Proof Starters;
- Pump Panel Controllers.

Whenever you need a reliable product to control & protect your application, WEG field specialists can help you find the best solution.

New Concepts

Smaller size components allow selection of smaller enclosures which translates to cost savings. A wide range of ratings and frames allow the components to be more closely matched to your application. Our overload relays provide phase loss sensitivity, ambient temperature compensated for -4F to +140F (eliminating the need for additional heaters), and automatic reset for remote applications.

A wide range of industrial applications are covered: Pumps, Industrial Washing Machines, Compressors, Blowers, Cutting Machines, Conveyors, Lumber Processing and many others.



Controls

Enclosed Starters

Non-Combination Starters



WEG offers non-reversing and non-combination magnetic starters up to 75HP at 460Vac (105A). Featuring components that meet IEC design standards and UL horsepower ratings, incorporating WEG contactors and overload relays, the magnetic starters are ideal to protect and operate motors, ensuring smooth operation year-after year.

Three series are available:

- Metallic Type 1 – ESW Series
- Non-Metallic Type 4X – PESW Series
- Aluminum Type NEMA 7/9 - ESWX Series

WEG ESW and PESW starters are pre-wired from the factory and recommended for all single and three phase applications where magnetic starters can be applied.

Main Characteristics and Features

- High horsepower ratings in four compact sizes
- Fast acceleration and high initial torque
- Bimetallic Overload Relays – class 10
- Adjustable trip current
- Ambient temperature compensated
- Phase-loss sensitivity protection
- Selectable Manual or Automatic RESET
- Electrically isolated NO-NC auxiliary contacts
- Easy to install and setup

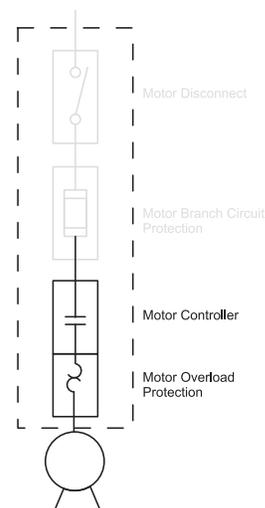

Controls Enclosed Starters

Combination Starters



WEG's full voltage non-reversing combination starters represent a competitive alternative to the traditional NEMA starters by offering:

- reduced overall dimensions, yet providing reasonable internal wiring space;
- rotary through-the-door disconnect instead of the traditional flange operator; and
- UL/CSA approved performance in more compact components.

Four series are available off the shelf:

- Fusible disconnect – ESWA Series;
- MCCB disconnect – ESWC Series;
- Motor protector – ESWE & ESWF Series;
- Pump controllers – ESWA (P) Series.

Available enclosures include Type 3R Raintight, Type 12 Dusttight, Type 4 Watertight and Type 4X Corrosion Resistance. Standard products range up to 250Hp at 460Vac (300A); higher horsepower ratings are available as customs panels.

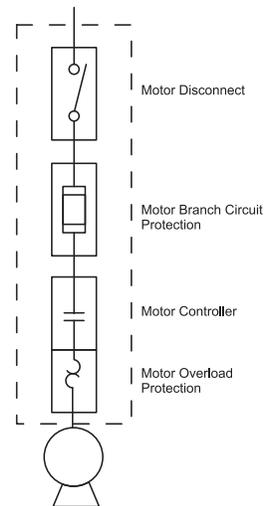

Pump Controllers



Ranging from 3 to 250HP@460Vac, all WEG Pump Controllers are UL listed full voltage, non-reversing combination starters and are available with through-the-door disconnect and fusible protection. They are assembled in a weather-tight NEMA 3R enclosure with hinged door and post mounting. Their oversized enclosures provide flexibility to accommodate additional accessories and to facilitate cable installation.

Other horsepower ratings, enclosure types and accessories are available as custom pump controllers.

WEG's pump control panels are designed to meet combination starter requirements in outdoor environmental conditions. Typical applications include irrigation and water treatment as well as oil well and agricultural applications.



Controls

Enclosed Starters

Combination Starter Basics

Combination starters are the most common type of packaged motor controllers. They are called combination because of their construction and combined functions required by the US National Electric Code (NEC): Motor Disconnect, Motor Branch Circuit Protection, Motor Controller and Motor Overload Protection. UL & CSA currently recognizes six different constructions of combination starters that meet the requirements of a motor branch circuit.

Constructions Types A through D are traditional starters that use either a listed disconnect switch and fuses or a listed circuit breaker as the disconnect means and for short circuit protection. Each type uses a separate UL508 listed motor controller and overload relay. Recently revisions on UL508 introduced the Type E and Type F starters.

UL Combination Starter Type	Device Used for Component Function			
	Disconnected	Branch Circuit Protection	Motor Controller	Motor OL Relay
A	UL 98 Manual Disconnect	UL 248 Fuses	UL 508 Magnetic or Solid State Controller	UL 508 Motor Overload Relay
B		UL 508 Motor Short Circuit Protector		
C	UL 489 Inverse Time Circuit Breaker			
D	UL 489 Instantaneous Trip Circuit Breaker			
E	UL 508 Self-Protected Combination Controller			
F	UL 508 Manual Self-Protected Combination Controller	UL 508 Magnetic or Solid State Controller	UL 508 Manual Self-Protected Combination Controller	

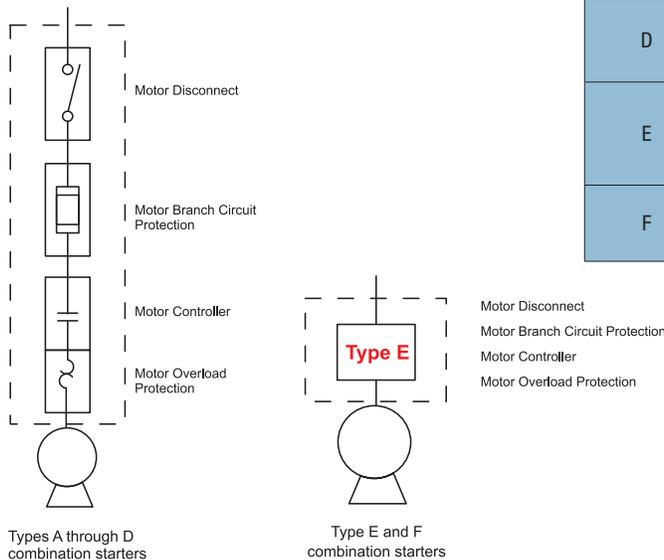

Type E starter is a self-protected combination motor controller that combines in a single device all the required functions of a combination starter eliminating any additional requirements for upstream fuses or circuit breaker. Type F starter consists of a listed manual Type E combined with a UL508 listed contactor.



Controls Enclosed Starters

Product Line Overview

	NON-COMBINATION STARTERS				COMBINATION STARTERS			
Type	ESW	PESW	ESWX	ESWA	ESWC	ESWE	ESWF	ESWA (Pump Control)
Maximum Horsepower Rating at 460Vac 60Hz [Hp]	75	75	10	250	250	20	75	250
Maximum Rated Current I _{max} (I ₁) [A]	105	105	16	300	300	32	105	300
Rated Operational Voltage [V]	600	600	600	600	600	600	600	600
Enclosure Type	Metallic Type 1	Non-Metallic Type 4X	Cast Aluminum Nema 7/9 Nema 4X	Metallic Type 1 Type 3R Type 4 / 12 Non-Metallic Type 4X	Metallic Type 1 Type 3R Type 4 / 12 Non-Metallic Type 4X	Non-Metallic Type 4X	Metallic Type 1 Type 3R Type 4 / 12 Non-Metallic Type 4X	Metallic Type 3R
Protections provided								
Motor Disconnect			✓	✓	✓	✓	✓	✓
Motor Branch Short-Circuit			✓	✓	✓	✓	✓	✓
Motor Controller	✓	✓	✓	✓	✓	✓	✓	✓
Motor Overload	✓	✓	✓	✓	✓	✓	✓	✓
Accessories								
Pushbuttons (CSW Series)	N/A	N/A	N/A					
Pilot light (CSW Series)	N/A	N/A	N/A					
Emergency Stop (CSW Series)	N/A	N/A	N/A					
Timing Relays (RTW Series)	N/A	N/A	N/A					
Protector Relay (RPW Series)	N/A	N/A	N/A					
Level Relay (RNW Series)	N/A	N/A	N/A					



Controls Enclosed Starters

Part Number Composition

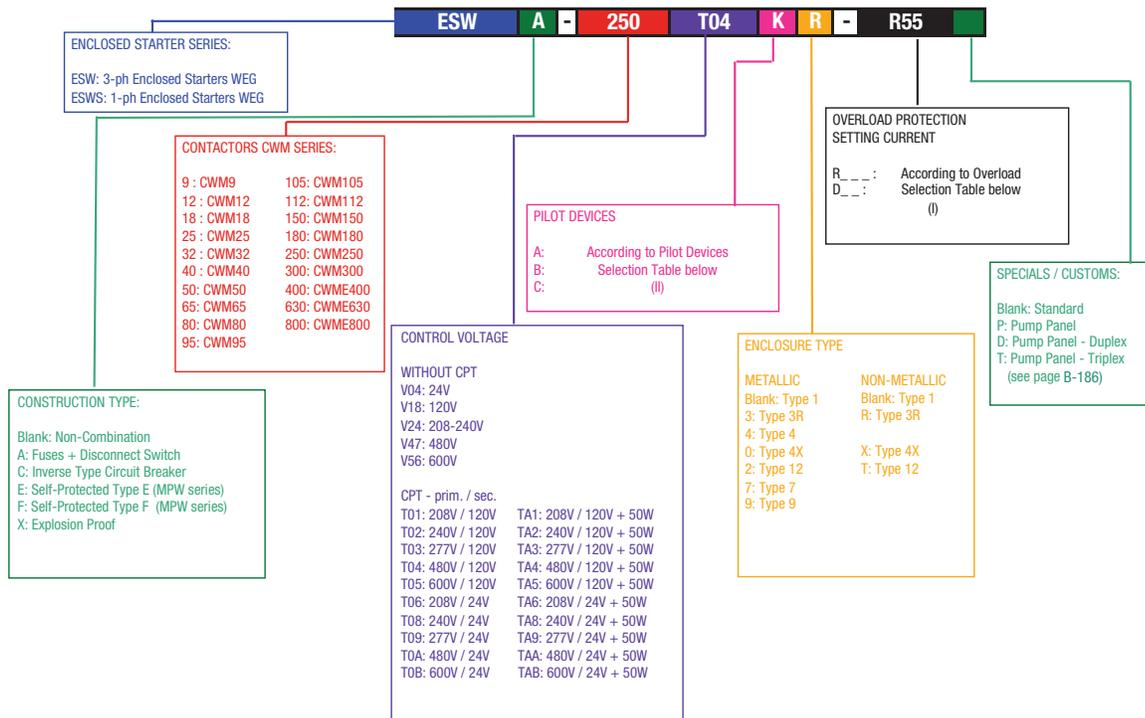

(II) Pilot devices Selection Table

Code	Description
A	ON + OFF + RESET
B	H-O-A SWITCH + ON + OFF + RESET
C	ON-OFF SELECTOR SWITCH + RESET
D	OFF + RESET
E	RESET
G	ON-OFF SELECTOR SWITCH + ON + OFF
H	H-O-A SELECTOR SWITCH
I	NONE
J	ON + OFF + ROTARY HANDLE + PILOT LIGHTS
K	H-O-A SELECTOR SWITCH + ON + OFF + ROTARY HANDLE+ PILOT LIGHTS
L	ON-OFF KEY
M	H-O-A SELECTOR SWITCH + ON + OFF + RESET
N	H-O-A SELECTOR SWITCH + ON + OFF + ROTARY HANDLE





Controls Enclosed Starters

Part Number Composition

(1) Overload Selection Table

Bimetallic Overload Relay								Manual Motor Protector			
Single-Phase		Setting Range (A)		Three-Phase		Setting Range (A)		Three-Phase		Setting Range (A)	
Code	Product	Min.	Max.	Code	Product	Min.	Max.	Code	Product	Min.	Max.
RM01	RW17-1D2-D004	0.28	0.40	R01	RW17-1D3-D004	0.28	0.40	D01	MPW25-3-C016	0.10	0.16
RM02	RW17-1D2-C063	0.40	0.63	R02	RW17-1D3-C063	0.40	0.63	D02	MPW25-3-C025	0.16	0.25
RM03	RW17-1D2-D008	0.56	0.80	R03	RW17-1D3-D008	0.56	0.80	D03	MPW25-3-C040	0.25	0.40
RM04	RW17-1D2-D012	0.80	1.20	R04	RW17-1D3-D012	0.80	1.20	D04	MPW25-3-C063	0.40	0.63
RM05	RW17-1D2-D018	1.20	1.80	R05	RW17-1D3-D018	1.20	1.80	D05	MPW25-3-U001	0.63	1.00
RM06	RW17-1D2-D028	1.80	2.80	R06	RW17-1D3-D028	1.80	2.80	D06	MPW25-3-D016	1.00	1.60
RM07	RW17-1D2-U004	2.80	4.00	R07	RW17-1D3-U004	2.80	4.00	D07	MPW25-3-D025	1.60	25.0
RM08	RW17-1D2-D063	4.00	6.30	R08	RW17-1D3-D063	4.00	6.30	D08	MPW25-3-U004	2.50	4.00
RM09	RW17-1D2-U008	5.60	8.00	R09	RW17-1D3-U008	5.60	8.00	D09	MPW25-3-D063	4.00	6.30
RM10	RW17-1D2-U010	7.00	10.0	R10	RW17-1D3-U010	7.00	10.0	D10	MPW25-3-U010	6.30	10.0
RM11	RW17-1D2-D125	8.00	12.5	R11	RW17-1D3-D125	8.00	12.5	D11	MPW25-3-U016	10.00	16.0
RM12	RW17-1D2-U015	10.0	15.0	R12	RW17-1D3-U015	10.0	15.0	D12	MPW25-3-U020	16.0	20.0
RM13	RW17-1D2-U017	11.0	17.0	R13	RW17-1D3-U017	11.0	17.0	D13	MPW25-3-U025	20.0	25.0
RM14	RW17-2D2-U010	7.00	10.0	R14	RW17-2D3-U010	7.00	10.0	D14	MPW25-3-U032	25.0	32.0
RM15	RW17-2D2-D125	8.00	12.5	R15	RW17-2D3-D125	8.00	12.5	D15	MPW65-3-U016	10.0	16.0
RM16	RW17-2D2-U015	10.0	15.0	R16	RW17-2D3-U015	10.0	15.0	D16	MPW65-3-U020	16.0	20.0
RM17	RW17-2D2-U017	11.0	17.0	R17	RW17-2D3-U017	11.0	17.0	D17	MPW65-3-U025	20.0	25.0
RM18	RW17-2D2-U023	15.0	23.0	R18	RW17-2D3-U023	15.0	23.0	D18	MPW65-3-U032	25.0	32.0
RM19	RW17-2D2-U032	22.0	32.0	R19	RW17-2D3-U032	22.0	32.0	D19	MPW65-3-U040	32.0	40.0
RM20	RW27-1D2-D004	0.28	0.40	R20	RW27-1D3-D004	0.28	0.40	D20	MPW65-3-U050	40	50
RM21	RW27-1D2-C063	0.40	0.63	R21	RW27-1D3-C063	0.40	0.63	D21	MPW65-3-U065	50	65
RM22	RW27-1D2-D008	0.56	0.80	R22	RW27-1D3-D008	0.56	0.80	D22	MPW100-3-U075	55	75
RM23	RW27-1D2-D012	0.80	1.20	R23	RW27-1D3-D012	0.80	1.20	D23	MPW100-3-U090	70	90
RM24	RW27-1D2-D018	1.20	1.80	R24	RW27-1D3-D018	1.20	1.80	D24	MPW100-3-U100	80	100
RM25	RW27-1D2-D028	1.80	2.80	R25	RW27-1D3-D028	1.80	2.80				
RM26	RW27-1D2-U004	2.80	4.00	R26	RW27-1D3-U004	2.80	4.00				
RM27	RW27-1D2-D063	4.00	6.30	R27	RW27-1D3-D063	4.00	6.30				
RM28	RW27-1D2-U008	5.60	8.00	R28	RW27-1D3-U008	5.60	8.00				
RM29	RW27-1D2-U010	7.00	10.0	R29	RW27-1D3-U010	7.00	10.0				
RM30	RW27-1D2-D125	8.00	12.5	R30	RW27-1D3-D125	8.00	12.5				
RM31	RW27-1D2-U015	10.0	15.0	R31	RW27-1D3-U015	10.0	15.0				
RM32	RW27-1D2-U017	11.0	17.0	R32	RW27-1D3-U017	11.0	17.0				
RM33	RW27-1D2-U023	15.0	23.0	R33	RW27-1D3-U023	15.0	23.0				
RM34	RW27-1D2-U032	22.0	32.0	R34	RW27-1D3-U032	22.0	32.0				
RM35	RW67-1D2-U040	25.0	40.0	R35	RW67-1D3-U040	25.0	40.0				
RM36	RW67-2D2-U040	25.0	40.0	R37	RW67-1D3-U050	32.0	50.0				
RM38	RW67-2D2-U050	32.0	50.0	R38	RW67-2D3-U050	32.0	50.0				
RM39	RW67-2D2-U057	40.0	57.0	R39	RW67-2D3-U057	40.0	57.0				
RM40	RW67-2D2-U063	50.0	63.0	R40	RW67-2D3-U063	50.0	63.0				
RM41	RW67-2D2-U070	57.0	70.0	R41	RW67-2D3-U070	57.0	70.0				
RM42	RW67-2D2-U080	63.0	80.0	R42	RW67-2D3-U080	63.0	80.0				
				R43	RW117-1D3-U080						
				R44	RW117-1D3-U097						
				R45	RW117-1D3-U112						
				R46	RW117-2D3-U097						
				R47	RW117-2D3-U112						
				R48	RW317-1D3-U150						
				R49	RW317-1D3-U215						
				R50	RW317-1D3-U310						
				R51	RW317-1D3-U420						
				R52	RW317-1D3-U600						
				R53	RW317-1D3-U840						
				R54	RW407-1D3-U600						
				R55	RW407-1D3-U840						



Controls Enclosed Non-Combination Starters - PESW Series



NEMA 4/4X Non Metallic Enclosure – Product Features

WEG offers non-reversing and non-combination NEMA-4X magnetic starter up to 75HP at 460V.

Featuring components that meet IEC design standards and UL horsepower ratings, incorporating WEG contactors and overload relays, the PESW magnetic starters are ideal to protect motors and ensure reliable operation year-after-year. Assembled together in a NEMA 4X enclosure with two options off the shelf: Start/Stop Pushbutton and RESET or just the RESET button on the cover for quick and easy operation.

WEG PESW starters are recommended for all single and three phase applications where across-the-line starters can be applied.

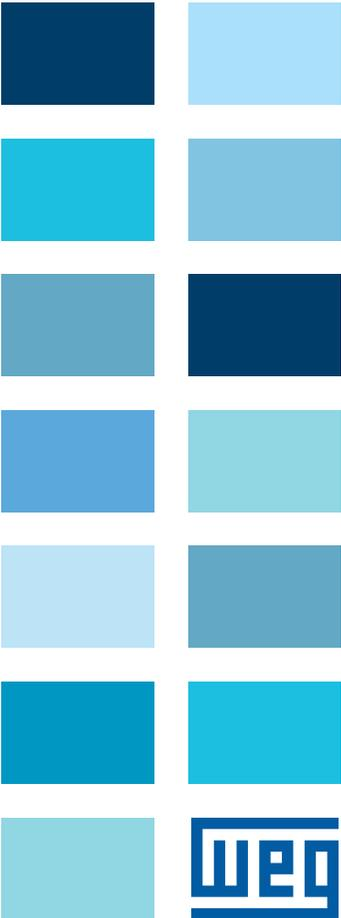

Certifications



Controls

Enclosed Non-Combination Starters - PESW Series



Start/Stop **contacts independent** from main contactor and from thermal overload relay

Ground and Neutral
(supplied as standard)



Thermal overload relay reset integrated to the stop button up to 30Hp, 460V



Enclosure:
NEMA 4X



MAIN CHARACTERISTICS AND FEATURES

- High horsepower ratings in four compact sizes
- Bimetallic Overload Relays
- Adjustable trip current
- Direct heated bimetallic elements – class 10
- Ambient temperature compensated
- Phase-loss sensitivity protection
- Selectable Manual or Automatic RESET
- Electrically isolated NO-NC auxiliary contacts
- NEMA 4X polymeric enclosure with knockouts



Controls

Enclosed Non-Combination Starters - PESW Series

Catalog part number composition

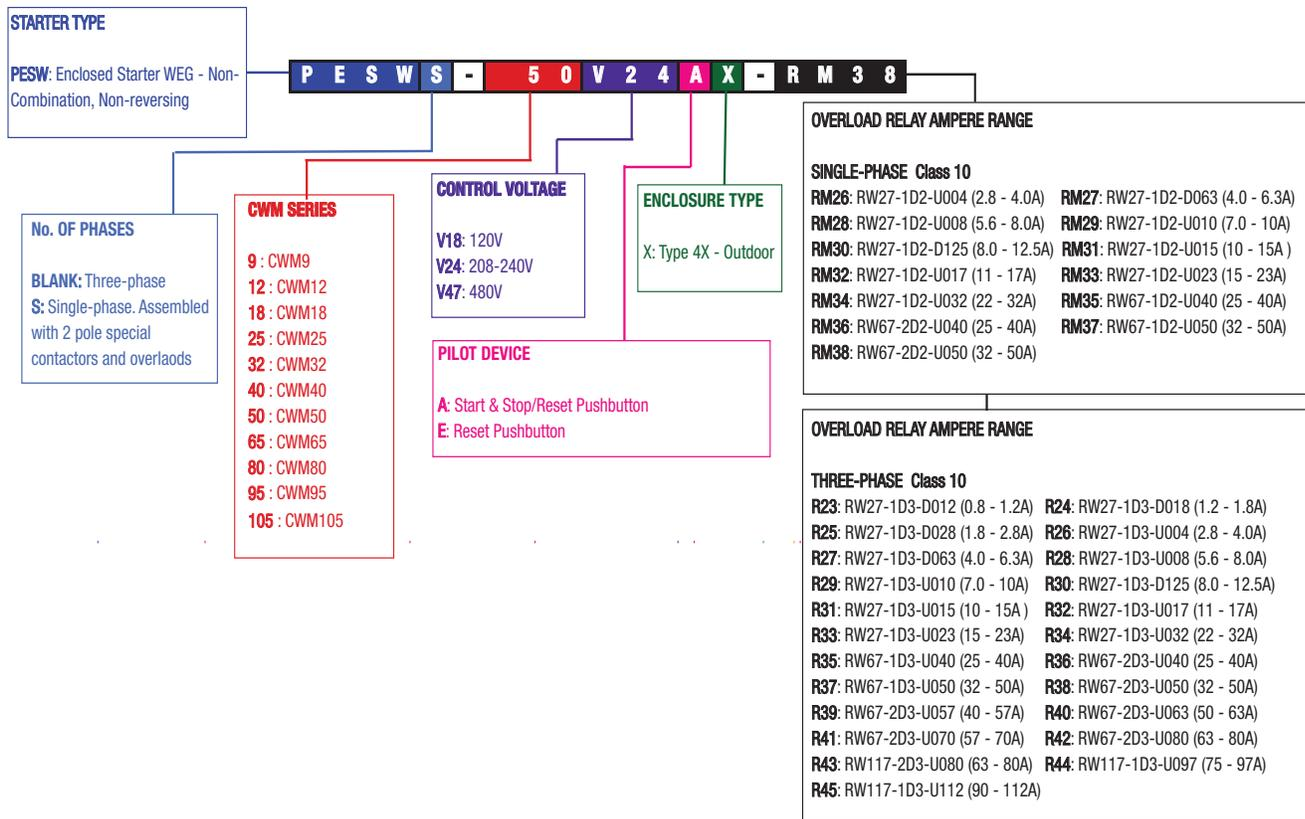

Controls

Enclosed Non-Combination Starters - PESW Series



Features and Benefits

- Motor protection from overload
- Non-corrosive, outdoor, wash down rated enclosure, ready-to-go even in the harshest environments
- Conveniently pre-wired with START/STOP 3-wire control and through-the-cover overload RESET
- Easy to install and setup

PESW Series - Non-combination Across the line starter

Single Phase- Enclosure Type-4X

Max. UL Horsepower		Box	Setting Range	Coil Voltage	RESET only ⁴	START/STOP + RESET	Multiplier Symbol
115V	230V				Catalog Number	Catalog Number	
-	1/2	04	2.8 - 4.0	208-240	PESWS-9V24EX-RM26	PESWS-9V24AX-RM26	Z3
-	3/4	04	4.0 - 6.3	208-240	PESWS-9V24EX-RM27	PESWS-9V24AX-RM27	Z3
1/3	1	04	5.6 - 8.0	120	PESWS-9V18EX-RM28	PESWS-9V18AX-RM28	Z3
				208-240	PESWS-9V24EX-RM28	PESWS-9V24AX-RM28	
1/2	-	04	7.0 - 10	120	PESWS-9V18EX-RM29	PESWS-9V18AX-RM29	Z3
-	1-1/2	04	8.0 - 12.5	208-240	PESWS-9V24EX-RM30	PESWS-9V24AX-RM30	Z3
				120	PESWS-12V18EX-RM31	PESWS-12V18AX-RM31	
3/4	2	04	10 - 15	208-240	PESWS-12V24EX-RM31	PESWS-12V24AX-RM31	Z3
				120	PESWS-18V18EX-RM32	PESWS-18V18AX-RM32	
1	3	04	11 - 17	208-240	PESWS-18V24EX-RM32	PESWS-18V24AX-RM32	Z3
				120	PESWS-25V18EX-RM33	PESWS-25V18AX-RM33	
1-1/2	5	04	15 - 23	208-240	PESWS-25V24EX-RM33	PESWS-25V24AX-RM33	Z3
				120	PESWS-25V18EX-RM34	PESWS-25V18AX-RM34	
2	5	04	22 - 32	208-240	PESWS-25V24EX-RM34	PESWS-25V24AX-RM34	Z3
				120	PESWS-40V18EX-RM35	PESWS-40V18AX-RM35	
3	-	06	25 - 40	120	PESWS-40V18EX-RM35	PESWS-40V18AX-RM35	Z3
-	7-1/2	08	25 - 40	208-240	PESWS-50V24EX-RM36	PESWS-50V24AX-RM36	Z3
-	7-1/2	08	32 - 50	208-240	PESWS-50V24EX-RM38	PESWS-50V24AX-RM38	Z3
-	10	08	32 - 50	208-240	PESWS-65V24EX-RM38	PESWS-65V24AX-RM38	Z3



Controls

Enclosed Non-Combination Starters - PESW Series

PESW Series - Non-combination Across the line starter										
Three-Phase Enclosure Type - 4X										
Max. UL Horsepower				Box	Setting Range	Coil Voltage	RESET only ⁶		START/STOP + RESET	Multiplier Symbol
200V	230V	460V	575V				RESET only ⁶ Catalog Number	Catalog Number		
-	1/3	1/2	-	04	0.8 - 1.2	120	PESW-9V18EX-R23	PESW-9V18AX-R23	Z3	
						208-240	PESW-9V24EX-R23	PESW-9V24AX-R23		
						480	PESW-9V47EX-R23	PESW-9V47AX-R23		
-	-	1	1	04	1.2 - 1.8	120	PESW-9V18EX-R24	PESW-9V18AX-R24	Z3	
						480	PESW-9V47EX-R24	PESW-9V47AX-R24		
1/2	3/4	1-1/2	2	04	1.8 - 2.8	120	PESW-9V18EX-R25	PESW-9V18AX-R25	Z3	
						208-240	PESW-9V24EX-R25	PESW-9V24AX-R25		
						480	PESW-9V47EX-R25	PESW-9V47AX-R25		
1	1	2	3	04	2.8 - 4.0	120	PESW-9V18EX-R26	PESW-9V18AX-R26	Z3	
						208-240	PESW-9V24EX-R26	PESW-9V24AX-R26		
						480	PESW-9V47EX-R26	PESW-9V47AX-R26		
1-1/2	1-1/2	3	5	04	4.0 - 6.3	120	PESW-9V18EX-R27	PESW-9V18AX-R27	Z3	
						208-240	PESW-9V24EX-R27	PESW-9V24AX-R27		
						480	PESW-9V47EX-R27	PESW-9V47AX-R27		
2	2	5	-	04	5.6 - 8.0	120	PESW-9V18EX-R28	PESW-9V18AX-R28	Z3	
						208-240	PESW-9V24EX-R28	PESW-9V24AX-R28		
						480	PESW-9V47EX-R28	PESW-9V47AX-R28		
3	3	-	7-1/2	04	7.0 - 10	120	PESW-9V18EX-R29	PESW-9V18AX-R29	Z3	
						208-240	PESW-9V24EX-R29	PESW-9V24AX-R29		
-	-	7-1/2	10	04	8.0 - 12.5	120	PESW-12V18EX-R30	PESW-12V18AX-R30	Z3	
						480	PESW-12V47EX-R30	PESW-12V47AX-R30		
5	5	10	15	04	11 - 17	120	PESW-18V18EX-R32	PESW-18V18AX-R32	Z3	
						208-240	PESW-18V24EX-R32	PESW-18V24AX-R32		
						480	PESW-18V47EX-R32	PESW-18V47AX-R32		
7-1/2	7-1/2	15	-	04	15 - 23	120	PESW-25V18EX-R33	PESW-25V18AX-R33	Z3	
						208-240	PESW-25V24EX-R33	PESW-25V24AX-R33		
						480	PESW-25V47EX-R33	PESW-25V47AX-R33		
10	10	20	25	06	22 - 32	120	PESW-32V18EX-R34	PESW-32V18AX-R34	Z3	
						208-240	PESW-32V24EX-R34	PESW-32V24AX-R34		
						480	PESW-32V47EX-R34	PESW-32V47AX-R34		
10	15	30	-	06	25 - 40	120	PESW-40V18EX-R35	PESW-40V18AX-R35	Z3	
						208-240	PESW-40V24EX-R35	PESW-40V24AX-R35		
						480	PESW-40V47EX-R35	PESW-40V47AX-R35		
15	15	30	40	08	32 - 50	120	PESW-50V18EX-R38	PESW-50V18AX-R38	Z3	
						208-240	PESW-50V24EX-R38	PESW-50V24AX-R38		
						480	PESW-50V47EX-R38	PESW-50V47AX-R38		
20	20	40	50	08	40 - 57	120	PESW-65V18EX-R39	PESW-65V18AX-R39	Z3	
						208-240	PESW-65V24EX-R39	PESW-65V24AX-R39		
						480	PESW-65V47EX-R39	PESW-65V47AX-R39		
-	25	50	60	08	57 - 70	120	PESW-80V18EX-R41	PESW-80V18AX-R41	Z3	
						208-240	PESW-80V24EX-R41	PESW-80V24AX-R41		
						480	PESW-80V47EX-R41	PESW-80V47AX-R41		
25	30	60	75	10	63 - 80	120	PESW-95V18EX-R43	PESW-95V18AX-R43	Z3	
						208-240	PESW-95V24EX-R43	PESW-95V24AX-R43		
						480	PESW-95V47EX-R43	PESW-95V47AX-R43		
30	-	75	-	10	75 - 97	120	PESW-105V18EX-R44	PESW-105V18AX-R44	Z3	
						480	PESW-105V47EX-R44	PESW-105V47AX-R44		
-	40	-	-	10	90 - 112	120	PESW-105V18EX-R45	PESW-105V18AX-R45	Z3	
						208-240	PESW-105V24EX-R45	PESW-105V24AX-R45		

Notes:

- 1) OLR must be set with FLA of the motor
- 2) 3-phase starters with 120V coil are wired for separate control
- 3) 3-phase starters can be wired for single-phase applications
- 4) 575V starters are available only with 120V coil
- 5) Only starters with 120V coil are stocked. Availability on other voltages under request.



Controls

Enclosed Non-Combination Starters - PESW Series

WIRING DIAGRAM

Single-phase Starter

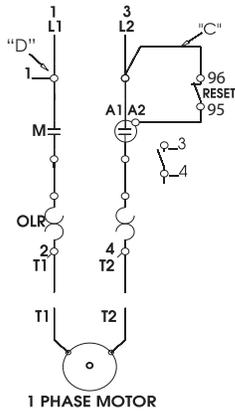

Three-phase Starter

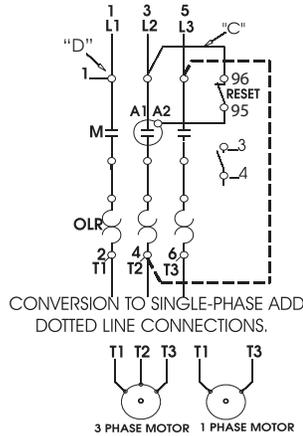

Separate Control

FOR SEPARATE CONTROL, REMOVE WIRES "C" AND "D" IF SUPPLIED AND CONNECT SEPARATE CONTROL LINES TO TERMINAL N° 96 ON THE OVERLOAD RELAY AND TO TERMINAL N° _3 ON THE AUX. CONTACT BLOCK (FOR 3 WIRE CONTROL) OR TO THE CONTACTOR COIL N° A1 (FOR 2 WIRE CONTROL).

Pilot Devices

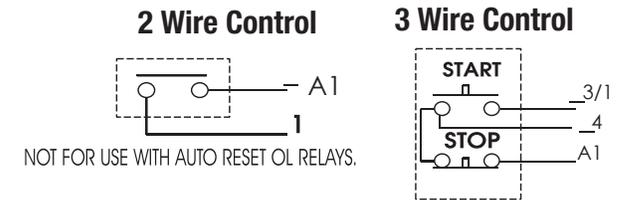

DIMENSIONS

SIZE 04 mm(in)	SIZE 06 mm (in)	SIZE 08 mm (in)	SIZE 10 mm (in)
øA = 4.5 (0.2)	øA = 6.5 (0.3)	øA = 6.0 (0.2)	øA = 7.0 (0.3)
B = 180 (7.1)	B = 205 (8.1)	B = 275 (10.8)	B = 355 (14.0)
C = 111 (4.4)	C = 126 (5.0)	C = 143 (5.6)	C = 167 (6.6)
D = 105 (4.1)	D = 120 (4.7)	D = 180 (7.1)	D = 250 (9.9)
E = 185 (7.3)	E = 210 (8.3)	E = 280 (11.0)	E = 360 (14.2)

Provision for cable gland fitting	Standard		
	Top	Bottom	Back
Size 04	2 x 1/2"	2 x 1/2"	ø18mm (0.7in)
Size 06	2 x 1/2" and 3/4"	2 x 1/2" and 3/4"	ø22mm (0.9in)
Size 08	2 x 3/4" and 1"	2 x 3/4" and 1"	-
Size 10	2 x 3/4" and 1"	2 x 3/4" and 1"	-
	1 x 1" and 1 1/4"	1 x 1" and 1 1/4"	-

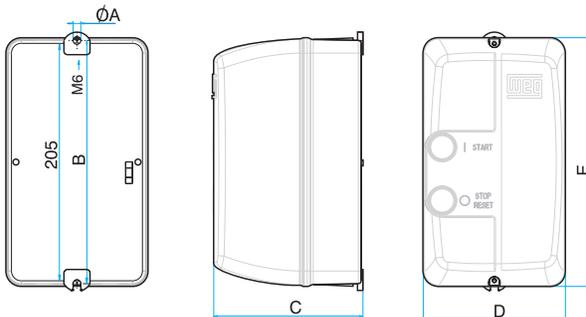

For wall mounting on starters size 08 and 10, four screws with the following characteristics should be used:

- Pan, dome or rounded shaped head;
- Starter size 08:
 - Screws size 1/4 (or M6 – ISO Standard);
 - Dimensions: diameter thread shall be maximum 1/4 in and diameter head shall be maximum 15/64 in.
- Starter size 10:
 - Screws size 12 (or M5 – ISO Standard);
 - Dimensions: diameter thread shall be maximum 0.236 in and diameter head shall be maximum 0.394 in.

Controls Enclosed Non-Combination Starters - ESW Series

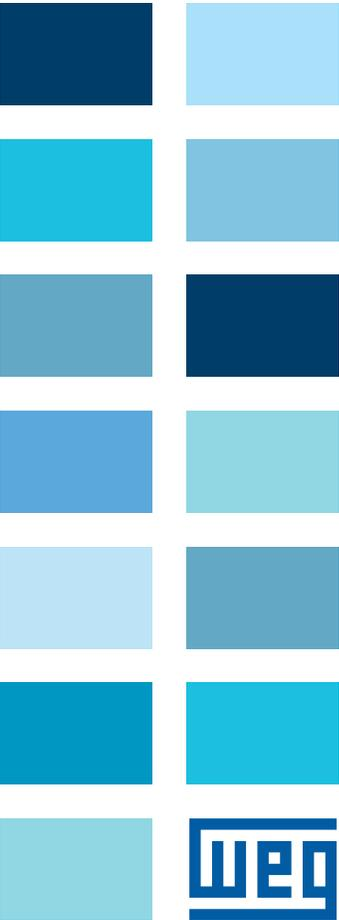

Ready to use

Enclosed Full Voltage magnetic starters are the most commonly used devices to switch AC motor loads. WEG's non-reversing non-combination starter consisting of a contactor and a bimetallic overload relay assembled together inside a NEMA type 1 enclosure. Two optional pilot devices are available factory-mounted. Either START / STOP pushbuttons or no-pilot device on the cover are on the shelves ready to go. Field Kit modifications are also available as accessories.

Certifications



Controls

Enclosed Non-Combination Starters - ESW Series

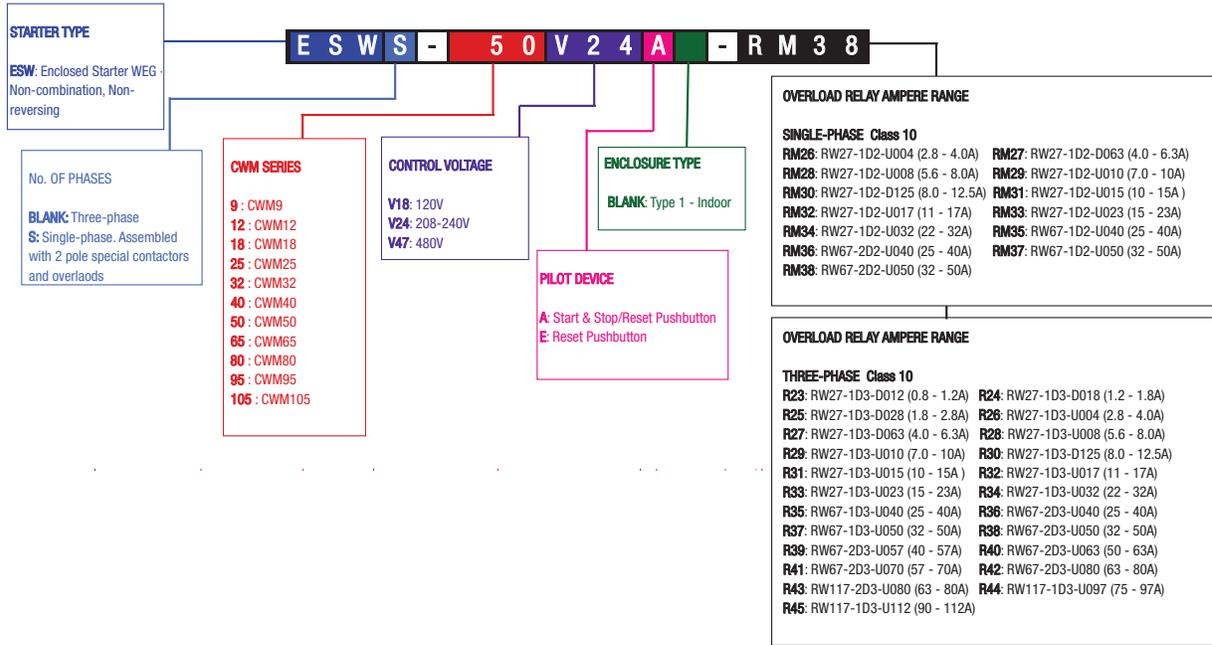

Controls

Enclosed Non-Combination Starters - ESW Series

NEMA 1 Enclosure – Three Phase

ESW Series - Non-combination Across The Line Starter									
Three -Phase - Enclosure Type-1									
Max. UL Horsepower				Box	Setting Range	Coil Voltage	RESET only	START/STOP + RESET	Multiplier Symbol
200V	230V	460V	575V				Catalog Number	Catalog Number	
-	1/3	1/2	-	M04	0.8 - 1.2	120	ESW-9V18E-R23	ESW-9V18A-R23	Z3
						208-240	ESW-9V24E-R23	ESW-9V24A-R23	
						480	ESW-9V47E-R23	ESW-9V47A-R23	
-	-	1	1	M04	1.2 - 1.8	120	ESW-9V18E-R24	ESW-9V18A-R24	Z3
						480	ESW-9V47E-R24	ESW-9V47A-R24	
1/2	3/4	1-1/2	2	M04	1.8 - 2.8	120	ESW-9V18E-R25	ESW-9V18A-R25	Z3
						208-240	ESW-9V24E-R25	ESW-9V24A-R25	
						480	ESW-9V47E-R25	ESW-9V47A-R25	
1	1	2	3	M04	2.8 - 4.0	120	ESW-9V18E-R26	ESW-9V18A-R26	Z3
						208-240	ESW-9V24E-R26	ESW-9V24A-R26	
						480	ESW-9V47E-R26	ESW-9V47A-R26	
1-1/2	1-1/2	3	5	M04	4.0 - 6.3	120	ESW-9V18E-R27	ESW-9V18A-R27	Z3
						208-240	ESW-9V24E-R27	ESW-9V24A-R27	
						480	ESW-9V47E-R27	ESW-9V47A-R27	
2	2	5	-	M04	5.6 - 8.0	120	ESW-9V18E-R28	ESW-9V18A-R28	Z3
						208-240	ESW-9V24E-R28	ESW-9V24A-R28	
						480	ESW-9V47E-R28	ESW-9V47A-R28	
3	3	-	7-1/2	M04	7.0 - 10	120	ESW-9V18E-R29	ESW-9V18A-R29	Z3
						208-240	ESW-9V24E-R29	ESW-9V24A-R29	
-	-	7-1/2	10	M04	8.0 - 12.5	120	ESW-12V18E-R30	ESW-12V18A-R30	Z3
						480	ESW-12V47E-R30	ESW-12V47A-R30	
5	5	10	15	M04	11 - 17	120	ESW-18V18E-R32	ESW-18V18A-R32	Z3
						208-240	ESW-18V24E-R32	ESW-18V24A-R32	
						480	ESW-18V47E-R32	ESW-18V47A-R32	
7-1/2	7-1/2	15	-	M04	15 - 23	120	ESW-25V18E-R33	ESW-25V18A-R33	Z3
						208-240	ESW-25V24E-R33	ESW-25V24A-R33	
						480	ESW-25V47E-R33	ESW-25V47A-R33	
10	10	20	25	M04	22 - 32	120	ESW-32V18E-R34	ESW-32V18A-R34	Z3
						208-240	ESW-32V24E-R34	ESW-32V24A-R34	
						480	ESW-32V47E-R34	ESW-32V47A-R34	
10	15	30	-	M06	25 - 40	120	ESW-40V18E-R35	ESW-40V18A-R35	Z3
						208-240	ESW-40V24E-R35	ESW-40V24A-R35	
						480	ESW-40V47E-R35	ESW-40V47A-R35	
15	15	30	40	M06	32 - 50	120	ESW-50V18E-R38	ESW-50V18A-R38	Z3
						208-240	ESW-50V24E-R38	ESW-50V24A-R38	
						480	ESW-50V47E-R38	ESW-50V47A-R38	
20	20	40	50	M06	40 - 57	120	ESW-65V18E-R39	ESW-65V18A-R39	Z3
						208-240	ESW-65V24E-R39	ESW-65V24A-R39	
						480	ESW-65V47E-R39	ESW-65V47A-R39	
-	25	50	60	M06	57 - 70	120	ESW-80V18E-R41	ESW-80V18A-R41	Z3
						208-240	ESW-80V24E-R41	ESW-80V24A-R41	
						480	ESW-80V47E-R41	ESW-80V47A-R41	
25	30	60	75	M08	63 - 80	120	ESW-95V18E-R43	ESW-95V18A-R43	Z3
						208-240	ESW-95V24E-R43	ESW-95V24A-R43	
						480	ESW-95V47E-R43	ESW-95V47A-R43	
30	-	75	-	M08	75 - 97	120	ESW-105V18E-R44	ESW-105V18A-R44	Z3
						480	ESW-105V47E-R44	ESW-105V47A-R44	
-	40	-	-	M08	90 - 112	120	ESW-105V18E-R45	ESW-105V18A-R45	Z3
						208-240	ESW-105V24E-R45	ESW-105V24A-R45	

Notes:

- 1) Please contact your local WEG representative for starters with other control voltage.
- 2) 3-phase starters can be wired for single-phase applications

Controls

Enclosed Non-Combination Starters - ESW Series

NEMA 1 Enclosure – Single Phase

ESW Series - Non-combination Across The Line Starter						
Single Phase - Enclosure Type-1						
Max. UL Horsepower		Box	Setting Range	Coil Voltage	RESET only	Multiplier Symbol
115V	230V				Catalog Number	
-	1/2	M04	2.8 - 4.0	208-240	ESWS-9V24E-RM26	Z3
-	3/4	M04	4.0 - 6.3	208-240	ESWS-9V24E-RM27	Z3
1/3	1	M04	5.6 - 8.0	120	ESWS-9V18E-RM28	Z3
				208-240	ESWS-9V24E-RM28	
1/2	-	M04	7.0 - 10	120	ESWS-9V18E-RM29	Z3
-	1-1/2	M04	8.0 - 12.5	208-240	ESWS-9V24E-RM30	Z3
				120	ESWS-12V18E-RM31	
3/4	2	M04	10 - 15	208-240	ESWS-12V24E-RM31	Z3
				120	ESWS-18V18E-RM32	
1	3	M04	11 - 17	208-240	ESWS-18V24E-RM32	Z3
				120	ESWS-25V18E-RM33	
1-1/2	5	M04	15 - 23	208-240	ESWS-25V24E-RM33	Z3
				120	ESWS-25V18E-RM34	
2	5	M04	22 - 32	208-240	ESWS-25V24E-RM34	Z3
				120	ESWS-40V18E-RM35	
-	7-1/2	M06	25 - 40	208-240	ESWS-50V24E-RM36	Z3
-	7-1/2	M06	32 - 50	208-240	ESWS-50V24E-RM38	Z3
-	10	M06	32 - 50	208-240	ESWS-65V24E-RM38	Z3

Notes: 1) OLR must be set with FLA of the motor
 (S) = ESWS - Single-phase version - assembled with 2 pole contactor and 2 pole overload relays

Accessories	Field Kit Modifications				
	Description	Structure		Catalog Number	Multiplier Symbol
		Top	Bottom		
No Pilot Device Metal Brackets - 2 x 22mm holes w/ plugs	PLUG	PLUG	KESWPP	Z3	
Start / Stop Pushbutton	PLUG	START - STOP	KESWPS	Z3	
Hand-Off-Auto Selector Switch	HAND - OFF - AUTO	PLUG	KESWHP	Z3	
Off-On Selector Switch	OFF - ON	PLUG	KESWFP	Z3	
Hand-Off-Auto Selector Switch and Start / Stop Pushbuttons	HAND - OFF - AUTO	START - STOP	KESWHS	Z3	



Controls

Enclosed Non-Combination Starters - ESW Series

WIRING DIAGRAM

Single-phase Starter

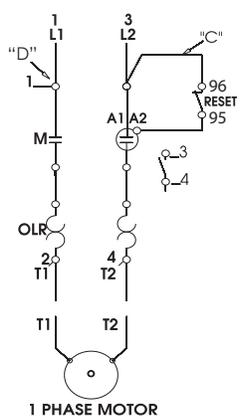

Three-phase Starter

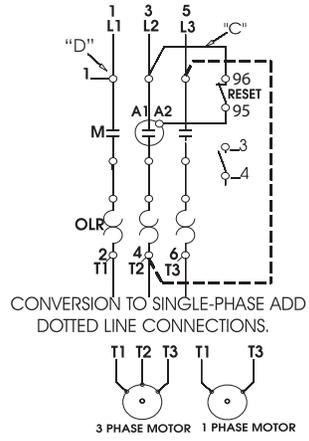

Separate Control

FOR SEPARATE CONTROL, REMOVE WIRES "C" AND "D" IF SUPPLIED AND CONNECT SEPARATE CONTROL LINES TO TERMINAL N° 96 ON THE OVERLOAD RELAY AND TO TERMINAL N° _3 ON THE AUX. CONTACT BLOCK (FOR 3 WIRE CONTROL) OR TO THE CONTACTOR COIL N° A1 (FOR 2 WIRE CONTROL).

Pilot Devices

2 Wire Control

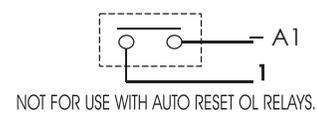

3 Wire Control

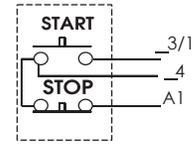

Hand-Off Auto Wire Control (For ESW Series Only)

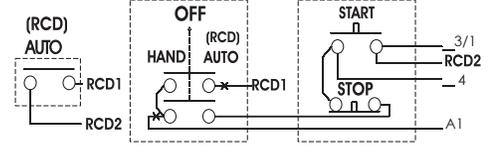

DIMENSIONS

Provision for cable gland fitting	Standard			
	Top	Bottom	Side	Back
Box M04	2x (1/2" or 3/4")	2x (1/2" or 3/4")	4x (1/2" or 3/4")	2x (1/2" or 3/4")
	1x (3/4" or 1")	1x (3/4" or 1")	-	-
Box M06	1x (1/2" or 3/4")	1x (1/2" or 3/4")	3x (1/2" or 3/4")	-
	2x (1" or 1-1/4")	2x (1" or 1-1/4")	4x (1" or 1-1/4")	-
Box M08	1x (1")	1x (1")	1x (1")	1x (1")
	1x (1-1/2")	1x (1-1/2")	4x (3/4")	-

Dimensions (approx. inches)				
Enclosed Starters	Enclosure Size			
	BOX	H	W	D
ESW(S) 9, 12, 18, 25, 32	M04	9.5	5.5	5.0
ESW(S) 40, 50, 65, 80	M06	13.0	7.5	5.6
ESW 95, 105	M08	17.8	9.5	6.7





Controls Enclosed Non-Combination Starters - ESWX Series

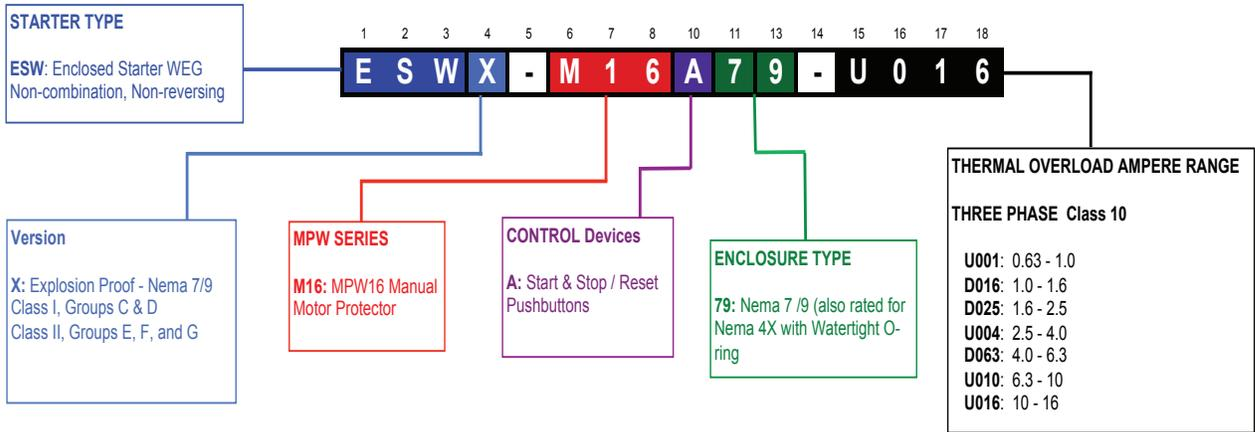

Controls

Manual Motor Starters - ESWX Series

Motor Control for Hazardous Areas: Class I, Groups C & D - Class II, Groups E, F, G

WEG Explosion Proof Manual Motors Starters are the perfect compliment for motor control in Hazardous and Industrial environments. Applications include Oil & Gas, and Mining, and Chemical Processing industries.



ESWX Series

- Motor Control
- Circuit Disconnect
- Short Circuit Protection up to 10 kA @ 600 VAC
- Thermal Overload Protection Class 10
- Control Devices: Start & Stop / Reset

Enclosure Specifications

- Versatile mounting format
- Corrosion resistant, copper free aluminum alloy body
- Bolted flange design
- Durable cast on lugs
- Watertight 'O' Rings for NEMA 4X applications
- Lockout device on pushbutton

Versions up to 75 HP available on request

ESWX - PRODUCT SELECTION					
Max 3 Phase UL HP		Thermal Setting	Short-Circuit interruption capacity	Catalog Number	Multiplier Symbol
Three Phase					
230V	460V	[A]	600V		
-	1/2	0.63 - 1.0	10kA	ESWX-M16A79-U001	Z33
-	3/4	1.0 - 1.6	10kA	ESWX-M16A79-D016	Z33
1/2	1	1.6 - 2.5	10kA	ESWX-M16A79-D025	Z33
3/4	2	2.5 - 4.0	10kA	ESWX-M16A79-U004	Z33
1 1/2	3	4.0 - 6.3	10kA	ESWX-M16A79-D063	Z33
3	5	6.3 - 10	10kA	ESWX-M16A79-U010	Z33
5	10	10 - 16	10kA	ESWX-M16A79-U016	Z33

Dimension

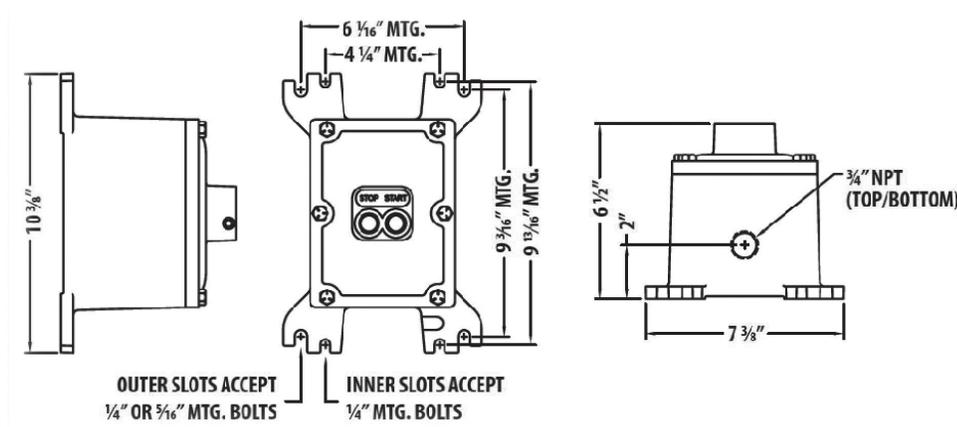

Controls Enclosed Combination Starters

Combination Starters



WEG's full voltage non-reversing combination starters represent a competitive alternative to the traditional NEMA starters by offering:

- reduced overall dimensions, yet providing reasonable internal wiring space;
- rotary through-the-door disconnect instead of the traditional flange operator; and
- UL/CSA approved performance in more compact components.

Four series are available off the shelf:

- Fusible disconnect – ESWA Series;
- MCCB disconnect – ESWC Series;
- Motor protector – ESWE & ESWF Series;
- Pump controllers – ESWA (P) Series.

Available enclosures include, Type 3R Raintight, Type 12 Dusttight, Type 4 Watertight and Type 4X Corrosion Resistance. Standard products range up to 250Hp at 460Vac (300A); higher horsepower ratings are available as custom panels.

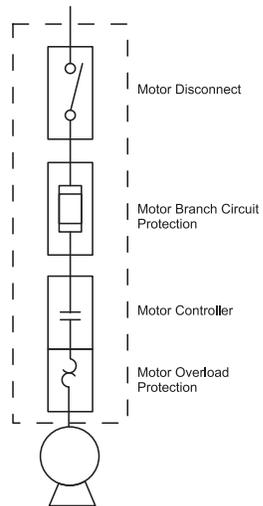

Controls

Enclosed Combination Starters

ESWA Series - Combination Type-A Across The Line Starter

THREE-PHASE without Control Power Transformer

Power fuses not included

- Branch Disconnect: Rotary through-the-door Handle
- Short-Circuit Protection: Fuses Class J not included
- Motor Control: Magnetic Contactor
- Overload Protection: Thermal Overload Relay
- Control Devices: Hand-Off-Auto switch, Start-Stop and reset pushbutton
- Non-metallic NEMA 4X available on request

ESWA Series - Combination Type-A Across The Line Starter								
Max. 3-ph Hp Motors				Overload Setting Range (A)	Control Voltage (1) (Vac)	Metallic Enclosure Type 4/12		Multiplier Symbol
200V	230V	460V	575V			Catalog Number	Box Size	
1-1/2	1-1/2	3	5	4 - 6.3	120	ESWA-9V18N4-R27	C	Z3
					208-240	ESWA-9V24N4-R27		
					480	ESWA-9V47N4-R27		
2	3	5	5	5.6 - 8	120	ESWA-9V18N4-R28	C	Z3
					208-240	ESWA-9V24N4-R28		
					480	ESWA-9V47N4-R28		
3	3	7 1/2	7 1/2	8 - 12.5	120	ESWA-12V18N4-R30	C	Z3
					208-240	ESWA-12V24N4-R30		
					480	ESWA-12V47N4-R30		
5	5	10	15	11 - 17	120	ESWA-18V18N4-R32	C	Z3
					208-240	ESWA-18V24N4-R32		
					480	ESWA-18V47N4-R32		
5	7-1/2	15	15	15 - 23	120	ESWA-25V18N4-R33	C	Z3
					208-240	ESWA-25V24N4-R33		
					480	ESWA-25V47N4-R33		
7 1/2	10	20	25	22 - 32	120	ESWA-32V18N4-R34	E	Z3
					208-240	ESWA-32V24N4-R34		
					480	ESWA-32V47N4-R34		
10	15	25	30	25 - 40	120	ESWA-40V18N4-R35	E	Z3
					208-240	ESWA-40V24N4-R35		
					480	ESWA-40V47N4-R35		
15	15	30	40	32 - 50	120	ESWA-50V18N4-R38	E	Z3
					208-240	ESWA-50V24N4-R38		
					480	ESWA-50V47N4-R38		
15	20	40	50	40 - 57	120	ESWA-65V18N4-R39	E	Z3
					208-240	ESWA-65V24N4-R39		
					480	ESWA-65V47N4-R39		
20	25	50	60	57 - 70	120	ESWA-80V18N4-R41	E	Z3
					208-240	ESWA-80V24N4-R41		
					480	ESWA-80V47N4-R41		
25	30	60	75	63 - 80	120	ESWA-95V18N4-R43	E	Z3
					208-240	ESWA-95V24N4-R43		
					480	ESWA-95V47N4-R43		
30	40	75	100	75 - 97	120	ESWA-105V18N4-R44	F	Z3
					208-240	ESWA-105V24N4-R44		
					480	ESWA-105V47N4-R44		
40	60	100	125	100 - 150	120	ESWA-150V18N4-R48	G	Z3
					208-240	ESWA-150V24N4-R48		
					480	ESWA-150V47N4-R48		
50	60	125	150	140 - 215	120	ESWA-150V18N4-R49	H	Z3
					208-240	ESWA-150V24N4-R49		
					480	ESWA-150V47N4-R49		
60	75	150	200	140 - 215	120	ESWA-180V18N4-R49	H	Z3
					208-240	ESWA-180V24N4-R49		
					480	ESWA-180V47N4-R49		
75	100	200	250	200 - 310	120	ESWA-250V18N4-R50	H	Z3
					208-240	ESWA-250V24N4-R50		
					480	ESWA-250V47N4-R50		
100	125	250	300	275 - 420	120	ESWA-300V18N4-R51	H	Z3
					208-240	ESWA-300V24N4-R51		
					480	ESWA-300V47N4-R51		

Dimensions (inches)			
Box Size	Enclosure Size		
	H	W	D
A	12	12	8
B	14	12	8
C	16	12	8
D	20	16	8
E	24	16	8
F	36	24	12
G	42	36	12
H	60	36	12

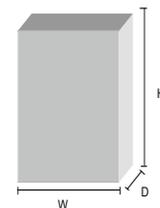

Controls

Enclosed Combination Starters

ESWA Series - Combination Type-A Across The Line Starter

THREE-PHASE with Control Power Transformer

Power fuses not included

- Branch Disconnect: Rotary through-the-door Handle
- Short-Circuit Protection: Fuses Class J not included
- Motor Control: Magnetic Contactor
- Overload Protection: Thermal Overload Relay
- Control Devices: Hand-Off-Auto switch, Start-Stop and reset pushbutton
- Non-metallic NEMA 4X available on request

ESWA Series - Combination Type-A Across The Line Starter with CPT								
Max. 3-ph Hp Motors				Overload Setting Range (A)	Control Voltage (prim. / sec.) (Vac)	Metallic Enclosure Type 4/12		Multiplier Symbol
200V	230V	460V	575V			Catalog Number	Box Size	
1-1/2	1-1/2	3	5	4 - 6.3	240 / 120	ESWA-9T02N4-R27	C	Z3
					480 / 120	ESWA-9T04N4-R27		
					575 / 120	ESWA-9T05N4-R27		
2	3	5	5	5.6 - 8	240 / 120	ESWA-9T02N4-R28	C	Z3
					480 / 120	ESWA-9T04N4-R28		
					575 / 120	ESWA-9T05N4-R28		
3	3	7 1/2	7 1/2	8 - 12.5	240 / 120	ESWA-12T02N4-R30	C	Z3
					480 / 120	ESWA-12T04N4-R30		
					575 / 120	ESWA-12T05N4-R30		
5	5	10	15	11 - 17	240 / 120	ESWA-18T02N4-R32	C	Z3
					480 / 120	ESWA-18T04N4-R32		
					575 / 120	ESWA-18T05N4-R32		
5	7-1/2	15	15	15 - 23	240 / 120	ESWA-25T02N4-R33	C	Z3
					480 / 120	ESWA-25T04N4-R33		
					575 / 120	ESWA-25T05N4-R33		
7 1/2	10	20	25	22 - 32	240 / 120	ESWA-32T02N4-R34	E	Z3
					480 / 120	ESWA-32T04N4-R34		
					575 / 120	ESWA-32T05N4-R34		
10	15	25	30	25 - 40	240 / 120	ESWA-40T02N4-R35	E	Z3
					480 / 120	ESWA-40T04N4-R35		
					575 / 120	ESWA-40T05N4-R35		
15	15	30	40	32 - 50	240 / 120	ESWA-50T02N4-R38	E	Z3
					480 / 120	ESWA-50T04N4-R38		
					575 / 120	ESWA-50T05N4-R38		
15	20	40	50	40 - 57	240 / 120	ESWA-65T02N4-R39	E	Z3
					480 / 120	ESWA-65T04N4-R39		
					575 / 120	ESWA-65T05N4-R39		
20	25	50	60	57 - 70	240 / 120	ESWA-80T02N4-R41	E	Z3
					480 / 120	ESWA-80T04N4-R41		
					575 / 120	ESWA-80T05N4-R41		
25	30	60	75	63 - 80	240 / 120	ESWA-95T02N4-R43	E	Z3
					480 / 120	ESWA-95T04N4-R43		
					575 / 120	ESWA-95T05N4-R43		
30	40	75	100	75 - 97	240 / 120	ESWA-105T02N4-R44	F	Z3
					480 / 120	ESWA-105T04N4-R44		
					575 / 120	ESWA-105T05N4-R44		
40	60	100	125	100 - 150	240 / 120	ESWA-150T02N4-R48	G	Z3
					480 / 120	ESWA-150T04N4-R48		
					575 / 120	ESWA-150T05N4-R48		
50	60	125	150	140 - 215	240 / 120	ESWA-150T02N4-R49	H	Z3
					480 / 120	ESWA-150T04N4-R49		
					575 / 120	ESWA-150T05N4-R49		
60	75	150	200	140 - 215	240 / 120	ESWA-180T02N4-R49	H	Z3
					480 / 120	ESWA-180T04N4-R49		
					575 / 120	ESWA-180T05N4-R49		
75	100	200	250	200 - 310	240 / 120	ESWA-250T02N4-R50	H	Z3
					480 / 120	ESWA-250T04N4-R50		
					575 / 120	ESWA-250T05N4-R50		
100	125	250	300	275 - 410	240 / 120	ESWA-300T02N4-R51	H	Z3
					480 / 120	ESWA-300T04N4-R51		
					575 / 120	ESWA-300T05N4-R51		

Notes:
 (1) Please contact your local WEG representative for starters with other control voltage.
 (2) 3-phase starters can be wired for single-phase applications

Dimensions (inches)			
Box Size	Enclosure Size		
	H	W	D
A	12	12	8
B	14	12	8
C	16	12	8
D	20	16	8
E	24	16	8
F	36	24	12
G	42	36	12
H	60	36	12

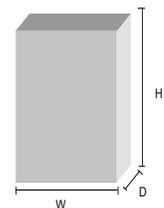

Controls

Enclosed Combination Starters

ESWC Series - Combination Type-C Across The Line Starter

THREE-PHASE without Control Power Transformer

- Branch Disconnect: Rotary through-the-door Handle
- Short-Circuit Protection: Molded Case Circuit Breaker
- Motor Control: Magnetic Contactor
- Overload Protection: Thermal Overload Relay
- Control Devices: Hand-Off-Auto switch, Start-Stop and reset pushbutton
- Non-metallic NEMA 4X available on request

ESWC Series - Combination Type-C Across The Line Starter with no CPT								
Max. 3-ph Hp Motors				Overload Setting Range (A)	Control Voltage (1) (Vac)	Metallic Enclosure Type 4/12		Multiplier Symbol
200V	230V	460V	575V			Catalog Number	Box Size	
1-1/2	1 1/2	3	5	4 - 6.3	120	ESWC-25V18N4-R27	C-1	Z3
					208-240	ESWC-25V24N4-R27		
					480	ESWC-25V47N4-R27		
2	2	5	5	5.6 - 8	120	ESWC-25V18N4-R28	C-1	Z3
					208-240	ESWC-25V24N4-R28		
					480	ESWC-25V47N4-R28		
3	3	7 1/2	7.5	8 - 12.5	120	ESWC-25V18N4-R30	C-1	Z3
					208-240	ESWC-25V24N4-R30		
					480	ESWC-25V47N4-R30		
5	5	10	10	11 - 17	120	ESWC-25V18N4-R32	C-1	Z3
					208-240	ESWC-25V24N4-R32		
					480	ESWC-25V47N4-R32		
7 1/2	7 1/2	15	15	15 - 23	120	ESWC-25V18N4-R33	C-1	Z3
					208-240	ESWC-25V24N4-R33		
					480	ESWC-25V47N4-R33		
10	10	20	25	22 - 32	120	ESWC-40V18N4-R34	C-1	Z3
					208-240	ESWC-40V24N4-R34		
					480	ESWC-40V47N4-R34		
10	15	25	25	25 - 40	120	ESWC-40V18N4-R35	C-1	Z3
					208-240	ESWC-40V24N4-R35		
					480	ESWC-40V47N4-R35		
10	15	30	-	32 - 50	120	ESWC-40V18N4-R37	C-1	Z3
					208-240	ESWC-40V24N4-R37		
					480	ESWC-40V47N4-R37		
20	20	40	50	40 - 57	120	ESWC-65V18N4-R39	C-1	Z3
					208-240	ESWC-65V24N4-R39		
					480	ESWC-65V47N4-R39		
20	20	50	-	57 - 70	120	ESWC-65V18N4-R41	C-1	Z3
					208-240	ESWC-65V24N4-R41		
					480	ESWC-65V47N4-R41		
25	30	60	60	63 - 80	120	ESWC-105V18N4-R43	C-1	Z3
					208-240	ESWC-105V24N4-R43		
					480	ESWC-105V47N4-R43		
30	40	75	75	75 - 97	120	ESWC-105V18N4-R44	C-1	Z3
					208-240	ESWC-105V24N4-R44		
					480	ESWC-105V47N4-R44		
40	60	100	125	100 - 150	120	ESWC-150V18N4-R48	C-2	Z3
					208-240	ESWC-150V24N4-R48		
					480	ESWC-150V47N4-R48		
50	60	125	150	140 - 215	120	ESWC-150V18N4-R49	C-2	Z3
					208-240	ESWC-150V24N4-R49		
					480	ESWC-150V47N4-R49		
60	75	150	200	140 - 215	120	ESWC-180V18N4-R49	C-2	Z3
					208-240	ESWC-180V24N4-R49		
					480	ESWC-180V47N4-R49		
75	100	200	250	200 - 310	120	ESWC-300V18N4-R50	C-3	Z3
					208-240	ESWC-300V24N4-R50		
					480	ESWC-300V47N4-R50		
100	125	250	300	275 - 420	120	ESWC-300V18N4-R51	C-3	Z3
					208-240	ESWC-300V24N4-R51		
					480	ESWC-300V47N4-R51		

Dimensions (inches)			
Box Size	Enclosure Size		
	H	W	D
C-1	24	16	8
C-2	32	24	12
C-3	40	32	12

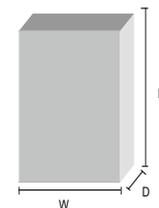

Notes:
 (1) Please contact your local WEG representative for starters with 575V control voltage.
 (2) 3-phase starters with 120V coil are pre-wired for separate control
 (3) 3-phase starters can be wired for single-phase applications



Controls

Enclosed Combination Starters

ESWC Series - Combination Type-C Across The Line Starter

THREE-PHASE with Control Power Transformer

- Branch Disconnect: Rotary through-the-door Handle
- Short-Circuit Protection: Molded Case Circuit Breaker
- Motor Control: Magnetic Contactor
- Overload Protection: Thermal Overload Relay
- Control Devices: Hand-Off-Auto switch, Start-Stop and reset pushbutton
- Non-metallic NEMA 4X available on request

ESWC Series - Combination Type-C Across The Line Starter with CPT

Max. 3-ph Hp Motors				Overload Setting Range (A)	Control Voltage (prim. / sec.) (Vac)	Metallic Enclosure Type 4/12		Multiplier Symbol
200V	230V	460V	575V			Catalog Number	Box Size	
1-1/2	1 1/2	3	5	4 - 6.3	240 / 120	ESWC-25T02N4-R27	C-1	Z3
					480 / 120	ESWC-25T04N4-R27		
					575 / 120	ESWC-25T05N4-R27		
2	2	5	5	5.6 - 8	240 / 120	ESWC-25T02N4-R28	C-1	Z3
					480 / 120	ESWC-25T04N4-R28		
					575 / 120	ESWC-25T05N4-R28		
3	3	7 1/2	7.5	8 - 12.5	240 / 120	ESWC-25T02N4-R30	C-1	Z3
					480 / 120	ESWC-25T04N4-R30		
					575 / 120	ESWC-25T05N4-R30		
5	5	10	10	11 - 17	240 / 120	ESWC-25T02N4-R32	C-1	Z3
					480 / 120	ESWC-25T04N4-R32		
					575 / 120	ESWC-25T05N4-R32		
7 1/2	7 1/2	15	15	15 - 23	240 / 120	ESWC-25T02N4-R33	C-1	Z3
					480 / 120	ESWC-25T04N4-R33		
					575 / 120	ESWC-25T05N4-R33		
10	10	20	25	22 - 32	240 / 120	ESWC-40T02N4-R34	C-1	Z3
					480 / 120	ESWC-40T04N4-R34		
					575 / 120	ESWC-40T05N4-R34		
10	15	25	25	25 - 40	240 / 120	ESWC-40T02N4-R35	C-1	Z3
					480 / 120	ESWC-40T04N4-R35		
					575 / 120	ESWC-40T05N4-R35		
10	15	30	-	32 - 50	240 / 120	ESWC-40T02N4-R37	C-1	Z3
					480 / 120	ESWC-40T04N4-R37		
					575 / 120	ESWC-40T05N4-R37		
20	20	40	50	40 - 57	240 / 120	ESWC-65T02N4-R39	C-1	Z3
					480 / 120	ESWC-65T04N4-R39		
					575 / 120	ESWC-65T05N4-R39		
20	20	50	-	57 - 70	240 / 120	ESWC-65T02N4-R41	C-1	Z3
					480 / 120	ESWC-65T04N4-R41		
					575 / 120	ESWC-65T05N4-R41		
25	30	60	60	63 - 80	240 / 120	ESWC-105T02N4-R43	C-1	Z3
					480 / 120	ESWC-105T04N4-R43		
					575 / 120	ESWC-105T05N4-R43		
30	40	75	75	75 - 97	240 / 120	ESWC-105T02N4-R44	C-1	Z3
					480 / 120	ESWC-105T04N4-R44		
					575 / 120	ESWC-105T05N4-R44		
40	60	100	125	100 - 150	240 / 120	ESWC-150T02N4-R48	C-2	Z3
					480 / 120	ESWC-150T04N4-R48		
					575 / 120	ESWC-150T05N4-R48		
50	60	125	150	140 - 215	240 / 120	ESWC-150T02N4-R49	C-2	Z3
					480 / 120	ESWC-150T04N4-R49		
					575 / 120	ESWC-150T05N4-R49		
60	75	150	200	140 - 215	240 / 120	ESWC-180T02N4-R49	C-2	Z3
					480 / 120	ESWC-180T04N4-R49		
					575 / 120	ESWC-180T05N4-R49		
75	100	200	250	200 - 310	240 / 120	ESWC-300T02N4-R50	C-3	Z3
					480 / 120	ESWC-300T04N4-R50		
					575 / 120	ESWC-300T05N4-R50		
100	125	250	300	275 - 420	240 / 120	ESWC-300T02N4-R51	C-3	Z3
					480 / 120	ESWC-300T04N4-R51		
					575 / 120	ESWC-300T05N4-R51		

Notes:

- (1) Please contact your local WEG representative for starters with other control voltage.
- (2) 3-phase starters can be wired for single-phase applications

Dimensions (inches)			
Box Size	Enclosure Size		
	H	W	D
C-1	24	16	8
C-2	32	24	12
C-3	40	32	12

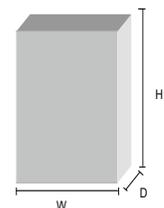

Controls

Enclosed Combination Starters

ESWE Series - Combination Type-E Across The Line Starter

- Branch Disconnect: Rotary through-the-door Handle
- Short-Circuit Protection: Manual Motor Protection
- Motor Control: Magnetic Contactor
- Overload Protection: Manual Motor Protection
- Control Devices: Hand-Off-Auto switch, Start-Stop pushbutton, pilot lights

Three-Phase without CPT - Enclosure Type-4X

ESWE Series - Combination Type-E Across The Line Starter								
Max. 3-ph Hp Motors				Overload Setting Range (A)	Control Voltage (1) (Vac)	Non-Metallic Enclosure Type 4X		Multiplier Symbol
200V	230V	460V	575V			Catalog Number	Box Size	
-	-	1/2	1/2	0.63 - 1.0	120	ESWE-9V18KX-D05	E-1	Z3
					480	ESWE-9V47KX-D05		
1/4	1/3	3/4	1	1.0 - 1.6	120	ESWE-9V18KX-D06	E-1	Z3
					208-240	ESWE-9V24KX-D06		
					480	ESWE-9V47KX-D06		
1/2	1/2	1-1/2	1-1/2	1.6 - 2.5	120	ESWE-9V18KX-D07	E-1	Z3
					208-240	ESWE-9V24KX-D07		
					480	ESWE-9V47KX-D07		
3/4	1	2	3	2.5 - 4.0	120	ESWE-9V18KX-D08	E-1	Z3
					208-240	ESWE-9V24KX-D08		
					480	ESWE-9V47KX-D08		
					120	ESWE-9V18KX-D09		
1-1/2	1-1/2	3	5	4.0 - 6.3	208-240	ESWE-9V24KX-D09	E-1	Z3
					480	ESWE-9V47KX-D09		
					120	ESWE-9V18KX-D10		
3	3	5	7-1/2	6.3 - 10	208-240	ESWE-9V24KX-D10	E-1	Z3
					480	ESWE-9V47KX-D10		
					120	ESWE-18V18KX-D11		
					208-240	ESWE-18V24KX-D11		
5	5	10	15	10 - 16	480	ESWE-18V47KX-D11	E-1	Z3
					120	ESWE-25V18KX-D12		
					208-240	ESWE-25V24KX-D12		
					480	ESWE-25V47KX-D12		
7-1/2	7-1/2	15	15	16 - 20	208-240	ESWE-40V18KX-D14	E-1	Z3
					480	ESWE-40V24KX-D14		
					120	ESWE-40V47KX-D14		
10	10	20	25	25 - 32	208-240	ESWE-40V24KX-D14	E-1	Z3
					480	ESWE-40V47KX-D14		
					120	ESWE-40V18KX-D14		
					208-240	ESWE-40V24KX-D14		

Three-Phase with CPT - Enclosure Type-4X

Max. 3-ph Hp Motors				Overload Setting Range (A)	Control Voltage (prim. / sec.) (Vac)	Non-Metallic Enclosure Type 4X		Multiplier Symbol
200V	230V	460V	575V			Catalog Number	Box Size	
-	-	1/2	1/2	0.63 - 1.0	480 / 120	ESWE-9T04KX-D05	E-1	Z3
					575 / 120	ESWE-9T05KX-D05		
					240 / 120	ESWE-9T02KX-D06		
1/4	1/3	3/4	1	1.0 - 1.6	480 / 120	ESWE-9T04KX-D06	E-1	Z3
					575 / 120	ESWE-9T05KX-D06		
					240 / 120	ESWE-9T02KX-D07		
1/2	1/2	1-1/2	1-1/2	1.6 - 2.5	480 / 120	ESWE-9T04KX-D07	E-1	Z3
					575 / 120	ESWE-9T05KX-D07		
					240 / 120	ESWE-9T02KX-D08		
3/4	1	2	3	2.5 - 4.0	480 / 120	ESWE-9T04KX-D08	E-1	Z3
					575 / 120	ESWE-9T05KX-D08		
					240 / 120	ESWE-9T02KX-D09		
					480 / 120	ESWE-9T04KX-D09		
1-1/2	1-1/2	3	5	4.0 - 6.3	575 / 120	ESWE-9T05KX-D09	E-1	Z3
					240 / 120	ESWE-9T02KX-D10		
					480 / 120	ESWE-9T04KX-D10		
3	3	5	7-1/2	6.3 - 10	575 / 120	ESWE-9T05KX-D10	E-1	Z3
					240 / 120	ESWE-18T02KX-D11		
					480 / 120	ESWE-18T04KX-D11		
					575 / 120	ESWE-18T05KX-D11		
5	5	10	15	10 - 16	240 / 120	ESWE-25T02KX-D12	E-1	Z3
					480 / 120	ESWE-25T04KX-D12		
					575 / 120	ESWE-25T05KX-D12		
7-1/2	7-1/2	15	15	16 - 20	480 / 120	ESWE-40T02KX-D14	E-1	Z3
					575 / 120	ESWE-40T04KX-D14		
					240 / 120	ESWE-40T05KX-D14		
10	10	20	25	25 - 32	480 / 120	ESWE-40T04KX-D14	E-1	Z3
					575 / 120	ESWE-40T05KX-D14		
					240 / 120	ESWE-40T02KX-D14		

Notes:

- (1) Please contact your local WEG representative for starters with 575V control voltage.
- (2) 3-phase starters with 120V coil are pre-wired for separate control
- (3) 3-phase starters can be wired for single-phase applications

Box Size	Enclosure Size		
	H	W	D
E-1	14.2	9.9	6.6

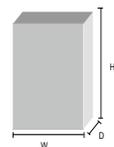



Controls Enclosed Combination Starters

ESWF Series - Combination Type-F Across The Line Starter THREE-PHASE without Control Power Transformer

- Branch Disconnect: Rotary through-the-door Handle
- Short-Circuit Protection: Manual Motor Protection
- Motor Control: Magnetic Contactor
- Overload Protection: Manual Motor Protection
- Control Devices: Hand-Off-Auto switch, Start-Stop pushbutton

ESWF Series - Combination Type-F Across The Line Starter with no CPT

Max. 3-ph Hp Motors				Overload Setting Range (A)	Control Voltage (1)(Vac)	Metallic Enclosure Type 3R		Metallic Enclosure Type 4/12		Non-Metallic Enclosure Type 4X		Multiplier Symbol
200V	230V	460V	575V			Catalog Number	Box Size	Catalog Number	Box Size	Catalog Number	Box Size	
-	-	1/2	1/2	0.63 - 1.0	120	ESWF-9V18N3-D05	F-1	ESWF-9V18N4-D05	F-1	ESWF-9V18NX-D05	F-1	Z3
					480			ESWF-9V47N3-D05		ESWF-9V47N4-D05		
1/4	1/3	3/4	1	1.0 - 1.6	120	ESWF-9V18N3-D06	F-1	ESWF-9V18N4-D06	F-1	ESWF-9V18NX-D06	F-1	Z3
					208-240			ESWF-9V24N3-D06		ESWF-9V24N4-D06		
					480	ESWF-9V47N3-D06	F-1	ESWF-9V47N4-D06	F-1	ESWF-9V47NX-D06	F-1	Z3
					120			ESWF-9V18N3-D07		ESWF-9V18N4-D07		
1/2	1/2	1-1/2	1-1/2	1.6 - 2.5	208-240	ESWF-9V24N3-D07	F-1	ESWF-9V24N4-D07	F-1	ESWF-9V24NX-D07	F-1	Z3
					480			ESWF-9V47N3-D07		ESWF-9V47N4-D07		
					120	ESWF-9V18N3-D08	F-1	ESWF-9V18N4-D08	F-1	ESWF-9V18NX-D08	F-1	Z3
					208-240			ESWF-9V24N3-D08		ESWF-9V24N4-D08		
3/4	1	2	3	2.5 - 4.0	480	ESWF-9V47N3-D08	F-1	ESWF-9V47N4-D08	F-1	ESWF-9V47NX-D08	F-1	Z3
					120			ESWF-9V18N3-D09		ESWF-9V18N4-D09		
1-1/2	1-1/2	3	5	4.0 - 6.3	208-240	ESWF-9V24N3-D09	F-1	ESWF-9V24N4-D09	F-1	ESWF-9V24NX-D09	F-1	Z3
					480			ESWF-9V47N3-D09		ESWF-9V47N4-D09		
					120	ESWF-9V18N3-D10	F-1	ESWF-9V18N4-D10	F-1	ESWF-9V18NX-D10	F-1	Z3
					208-240			ESWF-9V24N3-D10		ESWF-9V24N4-D10		
3	3	5	7 1/2	6.3 - 10	480	ESWF-9V47N3-D10	F-1	ESWF-9V47N4-D10	F-1	ESWF-9V47NX-D10	F-1	Z3
					120			ESWF-18V18N3-D11		ESWF-18V18N4-D11		
5	5	10	15	10 - 16	208-240	ESWF-18V24N3-D11	F-1	ESWF-18V24N4-D11	F-1	ESWF-18V24NX-D11	F-1	Z3
					480			ESWF-18V47N3-D11		ESWF-18V47N4-D11		
					120	ESWF-25V18N3-D12	F-2	ESWF-25V18N4-D12	F-2	ESWF-25V18NX-D12	F-2	Z3
					208-240			ESWF-25V24N3-D12		ESWF-25V24N4-D12		
7-1/2	7-1/2	15	15	16 - 20	480	ESWF-25V47N3-D12	F-2	ESWF-25V47N4-D12	F-2	ESWF-25V47NX-D12	F-2	Z3
					120			ESWF-40V18N3-D14		ESWF-40V18N4-D14		
10	10	20	25	25 - 32	208-240	ESWF-40V24N3-D14	F-2	ESWF-40V24N4-D14	F-2	ESWF-40V24NX-D14	F-2	Z3
					480			ESWF-40V47N3-D14		ESWF-40V47N4-D14		
					120	ESWF-50V18N3-D19	F-3	ESWF-50V18N4-D19	F-3	ESWF-50V18NX-D19	F-3	Z3
					208-240			ESWF-50V24N3-D19		ESWF-50V24N4-D19		
	15	25	30	32 - 40	480	ESWF-50V47N3-D19	F-3	ESWF-50V47N4-D19	F-3	ESWF-50V47NX-D19	F-3	Z3
					120			ESWF-65V18N3-D20		ESWF-65V18N4-D20		
15	15	30	40	40 - 50	208-240	ESWF-65V24N3-D20	F-3	ESWF-65V24N4-D20	F-3	ESWF-65V24NX-D20	F-3	Z3
					480			ESWF-65V47N3-D20		ESWF-65V47N4-D20		
					120	ESWF-80V18N3-D21	F-4	ESWF-80V18N4-D21	F-4	ESWF-80V18NX-D21	F-4	Z3
					208-240			ESWF-80V24N3-D21		ESWF-80V24N4-D21		
20	20	40	60	50 - 65	480	ESWF-80V47N3-D21	F-4	ESWF-80V47N4-D21	F-4	ESWF-80V47NX-D21	F-4	Z3
					120			ESWF-95V18N3-D22		ESWF-95V18N4-D22		
20	25	50	60	55 - 75	208-240	ESWF-95V24N3-D22	F-4	ESWF-95V24N4-D22	F-4	ESWF-95V24NX-D22	F-4	Z3
					480			ESWF-95V47N3-D22		ESWF-95V47N4-D22		
					120	ESWF-95V18N3-D23	F-4	ESWF-95V18N4-D23	F-4	ESWF-95V18NX-D23	F-4	Z3
					208-240			ESWF-95V24N3-D23		ESWF-95V24N4-D23		
25	30	60	75	70 - 90	480	ESWF-95V47N3-D23	F-4	ESWF-95V47N4-D23	F-4	ESWF-95V47NX-D23	F-4	Z3
					120			ESWF-105V18N3-D24		ESWF-105V18N4-D24		
30	30	75	100	80 - 100	208-240	ESWF-105V24N3-D24	F-4	ESWF-105V24N4-D24	F-4	ESWF-105V24NX-D24	F-4	Z3
					480			ESWF-105V47N3-D24		ESWF-105V47N4-D24		

Notes:

- (1) Please contact your local WEG representative for starters with 575V control voltage.
- (2) 3-phase starters with 120V coil are pre-wired for separate control
- (3) 3-phase starters can be wired for single-phase applications

Dimensions (Inches)			
Box Size	Enclosure Size		
	H	W	D
F-1	12	12	8
F-2	14	12	8
F-3	16	12	8
F-4	20	16	8

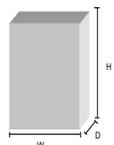

Controls

Enclosed Combination Starters

ESWF Series - Combination Type-F Across The Line Starter

THREE-PHASE with Control Power Transformer

- Branch Disconnect: Rotary through-the-door Handle
- Short-Circuit Protection: Manual Motor Protection
- Motor Control: Magnetic Contactor
- Overload Protection: Manual Motor Protection
- Control Devices: Hand-Off-Auto switch, Start-Stop pushbutton, control transformer

ESWF Series - Combination Type-F Across The Line Starter												
Max. 3-ph Hp Motors				Overload Setting Range (A)	Control Voltage (Vac)	Metallic Enclosure Type 3R		Metallic Enclosure Type 4/12		Non-Metallic Enclosure Type 4X		Multiplier Symbol
200V	230V	460V	575V			Catalog Number	Box Size	Catalog Number	Box Size	Catalog Number	Box Size	
-	-	1/2	1/2	0.63 - 1.0	480 / 120	ESWF-9T04N3-D05	F-1	ESWF-9T04N4-D05	F-1	ESWF-9T04NX-D05	F-1	Z3
					575 / 120	ESWF-9T05N3-D05		ESWF-9T05N4-D05		ESWF-9T05NX-D05		
1/4	1/3	3/4	1	1.0 - 1.6	240 / 120	ESWF-9T02N3-D06	F-1	ESWF-9T02N4-D06	F-1	ESWF-9T02NX-D06	F-1	Z3
					480 / 120	ESWF-9T04N3-D06		ESWF-9T04N4-D06		ESWF-9T04NX-D06		
					575 / 120	ESWF-9T05N3-D06		ESWF-9T05N4-D06		ESWF-9T05NX-D06		
1/2	1/2	1-1/2	1-1/2	1.6 - 2.5	240 / 120	ESWF-9T02N3-D07	F-1	ESWF-9T02N4-D07	F-1	ESWF-9T02NX-D07	F-1	Z3
					480 / 120	ESWF-9T04N3-D07		ESWF-9T04N4-D07		ESWF-9T04NX-D07		
					575 / 120	ESWF-9T05N3-D07		ESWF-9T05N4-D07		ESWF-9T05NX-D07		
3/4	1	2	3	2.5 - 4.0	240 / 120	ESWF-9T02N3-D08	F-1	ESWF-9T02N4-D08	F-1	ESWF-9T02NX-D08	F-1	Z3
					480 / 120	ESWF-9T04N3-D08		ESWF-9T04N4-D08		ESWF-9T04NX-D08		
					575 / 120	ESWF-9T05N3-D08		ESWF-9T05N4-D08		ESWF-9T05NX-D08		
1	1	3	5	4.0 - 6.3	240 / 120	ESWF-9T02N3-D09	F-1	ESWF-9T02N4-D09	F-1	ESWF-9T02NX-D09	F-1	Z3
1/2	1/2	3	5	4.0 - 6.3	480 / 120	ESWF-9T04N3-D09		ESWF-9T04N4-D09		ESWF-9T04NX-D09		
					575 / 120	ESWF-9T05N3-D09		ESWF-9T05N4-D09		ESWF-9T05NX-D09		
3	3	5	7 1/2	6.3 - 10	240 / 120	ESWF-9T02N3-D10	F-1	ESWF-9T02N4-D10	F-1	ESWF-9T02NX-D10	F-1	Z3
					480 / 120	ESWF-9T04N3-D10		ESWF-9T04N4-D10		ESWF-9T04NX-D10		
					575 / 120	ESWF-9T05N3-D10		ESWF-9T05N4-D10		ESWF-9T05NX-D10		
5	5	10	15	10 - 16	240 / 120	ESWF-18T02N3-D11	F-1	ESWF-18T02N4-D11	F-1	ESWF-18T02NX-D11	F-1	Z3
					480 / 120	ESWF-18T04N3-D11		ESWF-18T04N4-D11		ESWF-18T04NX-D11		
					575 / 120	ESWF-18T05N3-D11		ESWF-18T05N4-D11		ESWF-18T05NX-D11		
7-1/2	7 1/2	15	15	16 - 20	240 / 120	ESWF-25T02N3-D12	F-2	ESWF-25T02N4-D12	F-2	ESWF-25T02NX-D12	F-2	Z3
					480 / 120	ESWF-25T04N3-D12		ESWF-25T04N4-D12		ESWF-25T04NX-D12		
					575 / 120	ESWF-25T05N3-D12		ESWF-25T05N4-D12		ESWF-25T05NX-D12		
10	10	20	25	25 - 32	240 / 120	ESWF-40T02N3-D14	F-2	ESWF-40T02N4-D14	F-2	ESWF-40T02NX-D14	F-2	Z3
					480 / 120	ESWF-40T04N3-D14		ESWF-40T04N4-D14		ESWF-40T04NX-D14		
					575 / 120	ESWF-40T05N3-D14		ESWF-40T05N4-D14		ESWF-40T05NX-D14		
-	15	25	30	32 - 40	240 / 120	ESWF-50T02N3-D14	F-3	ESWF-50T02N4-D14	F-3	ESWF-50T02NX-D14	F-3	Z3
					480 / 120	ESWF-50T04N3-D19		ESWF-50T04N4-D19		ESWF-50T04NX-D19		
					575 / 120	ESWF-50T05N3-D19		ESWF-50T05N4-D19		ESWF-50T05NX-D19		
15	15	30	40	40 - 50	240 / 120	ESWF-65T02N3-D20	F-3	ESWF-65T02N4-D20	F-3	ESWF-65T02NX-D20	F-3	Z3
					480 / 120	ESWF-65T04N3-D20		ESWF-65T04N4-D20		ESWF-65T04NX-D20		
					575 / 120	ESWF-65T05N3-D20		ESWF-65T05N4-D20		ESWF-65T05NX-D20		
20	20	40	60	50 - 65	240 / 120	ESWF-80T02N3-D21	F-4	ESWF-80T02N4-D21	F-4	ESWF-80T02NX-D21	F-4	Z3
					480 / 120	ESWF-80T04N3-D21		ESWF-80T04N4-D21		ESWF-80T04NX-D21		
					575 / 120	ESWF-80T05N3-D21		ESWF-80T05N4-D21		ESWF-80T05NX-D21		
20	25	50	60	55 - 75	240 / 120	ESWF-95T02N3-D22	F-4	ESWF-95T02N4-D22	F-4	ESWF-95T02NX-D22	F-4	Z3
					480 / 120	ESWF-95T04N3-D22		ESWF-95T04N4-D22		ESWF-95T04NX-D22		
					575 / 120	ESWF-95T05N3-D22		ESWF-95T05N4-D22		ESWF-95T05NX-D22		
25	30	60	75	70 - 90	240 / 120	ESWF-95T02N3-D23	F-4	ESWF-95T02N4-D23	F-4	ESWF-95T02NX-D23	F-4	Z3
					480 / 120	ESWF-95T04N3-D23		ESWF-95T04N4-D23		ESWF-95T04NX-D23		
					575 / 120	ESWF-95T05N3-D23		ESWF-95T05N4-D23		ESWF-95T05NX-D23		
30	30	75	100	80 - 100	240 / 120	ESWF-105T02N3-D24	F-4	ESWF-105T02N4-D24	F-4	ESWF-105T02NX-D24	F-4	Z3
					480 / 120	ESWF-105T04N3-D24		ESWF-105T04N4-D24		ESWF-105T04NX-D24		
					575 / 120	ESWF-105T05N3-D24		ESWF-105T05N4-D24		ESWF-105T05NX-D24		

Notes:
 (1) Please contact your local WEG representative for starters with other control voltage.
 (2) 3-phase starters can be wired for single-phase applications

Dimensions (inches)			
Box Size	Enclosure Size		
	H	W	D
F-1	12	12	8
F-2	14	12	8
F-3	16	12	8
F-4	20	16	8

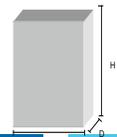



Controls Enclosed Combination Starters

Pump Controllers



Ranging from 3 to 250HP@460Vac, all WEG Pump Controllers are UL listed full voltage, non-reversing combination starters and are available with through-the-door disconnect and fusible protection. Assembled in a weather-tight NEMA 3R enclosure with hinged door and post mounting. Their oversized enclosures provide flexibility to accommodate additional accessories and to facilitate cable installation.

Other horsepower ratings, enclosure types and accessories are available as custom pump controllers.

WEG's pump control panels are designed to meet combination starter requirements in outdoor environmental conditions. Typical applications include irrigation and water treatment as well as oil well and agricultural applications.



Controls

Enclosed Combination Starters

ESWA Pump Controller Series - Combination Type-A Across The Line Starter

THREE-PHASE without Control Power Transformer

Power fuses not included

- Branch Disconnect: Rotary through-the-door Handle
- Short-Circuit Protection: Fuses Class J not included
- Motor Control: Magnetic Contactor
- Overload Protection: Thermal Overload Relay
- Control Devices: Hand-Off-Auto switch, Start-Stop and reset pushbutton

ESWA Pump Controller Series - Combination Type-A Across The Line Starter								
Max. 3-ph Hp Motors				Overload Setting Range	Coil Voltage	Metallic Enclosure Type 3R		Multiplier Symbol
2 00V	230V	460V	575V			Catalog Number	Box Size	
1-1/2	1-1/2	3	5	4 - 6.3	120	ESWA-9V18N3-R27P	D	Z3
					208-240	ESWA-9V24N3-R27P		
					480	ESWA-9V47N3-R27P		
2	3	5	5	5.6 - 8.0	120	ESWA-9V18N3-R28P	D	Z3
					208-240	ESWA-9V24N3-R28P		
					480	ESWA-9V47N3-R28P		
3	3	7 1/2	7 1/2	8.0 - 12.5	120	ESWA-12V18N3-R30P	D	Z3
					208-240	ESWA-12V24N3-R30P		
					480	ESWA-12V47N3-R30P		
5	5	10	15	11 - 17	120	ESWA-18V18N3-R32P	D	Z3
					208-240	ESWA-18V24N3-R32P		
					480	ESWA-18V47N3-R32P		
5	7-1/2	15	15	15 - 23	120	ESWA-25V18N3-R33P	D	Z3
					208-240	ESWA-25V24N3-R33P		
					480	ESWA-25V47N3-R33P		
7 1/2	10	20	25	22 - 32	120	ESWA-32V18N3-R34P	D	Z3
					208-240	ESWA-32V24N3-R34P		
					480	ESWA-32V47N3-R34P		
10	15	25	30	25 - 40	120	ESWA-40V18N3-R35P	D	Z3
					208-240	ESWA-40V24N3-R35P		
					480	ESWA-40V47N3-R35P		
15	15	30	40	32 - 50	120	ESWA-50V18N3-R38P	D	Z3
					208-240	ESWA-50V24N3-R38P		
					480	ESWA-50V47N3-R38P		
15	20	40	50	40 - 57	120	ESWA-65V18N3-R39P	O	Z3
					208-240	ESWA-65V24N3-R39P		
					480	ESWA-65V47N3-R39P		
20	25	50	60	57 - 70	120	ESWA-80V18N3-R41P	O	Z3
					208-240	ESWA-80V24N3-R41P		
					480	ESWA-80V47N3-R41P		
25	30	60	75	63 - 80	120	ESWA-95V18N3-R43P	O	Z3
					208-240	ESWA-95V24N3-R43P		
					480	ESWA-95V47N3-R43P		
30	40	75	100	75 - 97	120	ESWA-105V18N3-R44P	P	Z3
					208-240	ESWA-105V24N3-R44P		
					480	ESWA-105V47N3-R44P		
40	60	100	125	100 - 150	120	ESWA-150V18N3-R48P	P	Z3
					208-240	ESWA-150V24N3-R48P		
					480	ESWA-150V47N3-R48P		
50	60	125	150	140 - 215	120	ESWA-150V18N3-R49P	Q	Z3
					208-240	ESWA-150V24N3-R49P		
					480	ESWA-150V47N3-R49P		
60	75	150	200	140 - 215	120	ESWA-180V18N3-R49P	Q	Z3
					208-240	ESWA-180V24N3-R49P		
					480	ESWA-180V47N3-R49P		
75	100	200	250	200 - 310	120	ESWA-250V18N3-R50P	Q	Z3
					208-240	ESWA-250V24N3-R50P		
					480	ESWA-250V47N3-R50P		
100	125	250	300	275 - 420	120	ESWA-300V18N3-R51P	Q	Z3
					208-240	ESWA-300V24N3-R51P		
					480	ESWA-300V47N3-R51P		

Dimensions (inches)			
Box Size	Enclosure Size		
	H	W	D
D	20	16	8
O	30	20	10
P	44	24	10
Q	54	24	12

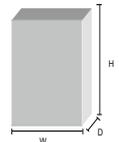

Controls

Enclosed Combination Starters

ESWA Pump Controller Series - Combination Type-A Across The Line Starter

THREE-PHASE with Control Power Transformer

Power fuses not included

- Branch Disconnect: Rotary through-the-door Handle
- Short-Circuit Protection: Fuses Class J not included
- Motor Control: Magnetic Contactor
- Overload Protection: Thermal Overload Relay
- Control Devices: Hand-Off-Auto switch, Start-Stop and reset pushbutton
- Control transformer

ESWA Pump Controller Series - Combination Type-A Across The Line Starter with CPT								
Max. 3-ph Hp Motors				Overload Setting Range (A)	Control Voltage (prim. / sec.) (Vac)	Metallic Enclosure Type 3R		Multiplier Symbol
200V	230V	460V	575V			Catalog Number	Box Size	
1-1/2	1-1/2	3	5	4.0 - 6.3	240 / 120	ESWA-9T02N3-R27P	D	Z3
					480 / 120	ESWA-9T04N3-R27P		
					575 / 120	ESWA-9T05N3-R27P		
2	3	5	5	5.6 - 8.0	240 / 120	ESWA-9T02N3-R28P	D	Z3
					480 / 120	ESWA-9T04N3-R28P		
					575 / 120	ESWA-9T05N3-R28P		
3	3	7 1/2	7 1/2	8.0 - 13	240 / 120	ESWA-12T02N3-R30P	D	Z3
					480 / 120	ESWA-12T04N3-R30P		
					575 / 120	ESWA-12T05N3-R30P		
5	5	10	15	11 - 17	240 / 120	ESWA-18T02N3-R32P	D	Z3
					480 / 120	ESWA-18T04N3-R32P		
					575 / 120	ESWA-18T05N3-R32P		
5	7-1/2	15	15	15 - 23	240 / 120	ESWA-25T02N3-R33P	D	Z3
					480 / 120	ESWA-25T04N3-R33P		
					575 / 120	ESWA-25T05N3-R33P		
7 1/2	10	20	25	22 - 32	240 / 120	ESWA-32T02N3-R34P	D	Z3
					480 / 120	ESWA-32T04N3-R34P		
					575 / 120	ESWA-32T05N3-R34P		
10	15	25	30	25 - 40	240 / 120	ESWA-40T02N3-R35P	D	Z3
					480 / 120	ESWA-40T04N3-R35P		
					575 / 120	ESWA-40T05N3-R35P		
15	15	30	40	32 - 50	240 / 120	ESWA-50T02N3-R38P	D	Z3
					480 / 120	ESWA-50T04N3-R38P		
					575 / 120	ESWA-50T05N3-R38P		
15	20	40	50	40 - 57	240 / 120	ESWA-65T02N3-R39P	O	Z3
					480 / 120	ESWA-65T04N3-R39P		
					575 / 120	ESWA-65T05N3-R39P		
20	25	50	60	57 - 70	240 / 120	ESWA-80T02N3-R41P	O	Z3
					480 / 120	ESWA-80T04N3-R41P		
					575 / 120	ESWA-80T05N3-R41P		
25	30	60	75	63 - 80	240 / 120	ESWA-95T02N3-R43P	O	Z3
					480 / 120	ESWA-95T04N3-R43P		
					575 / 120	ESWA-95T05N3-R43P		
30	40	75	100	75 - 97	240 / 120	ESWA-105T02N3-R44P	P	Z3
					480 / 120	ESWA-105T04N3-R44P		
					575 / 120	ESWA-105T05N3-R44P		
40	60	100	125	100 - 150	240 / 120	ESWA-150T02N3-R48P	P	Z3
					480 / 120	ESWA-150T04N3-R48P		
					575 / 120	ESWA-150T05N3-R48P		
50	60	125	150	140 - 215	240 / 120	ESWA-150T02N3-R49P	Q	Z3
					480 / 120	ESWA-150T04N3-R49P		
					575 / 120	ESWA-150T05N3-R49P		
60	75	150	200	140 - 215	240 / 120	ESWA-180T02N3-R49P	Q	Z3
					480 / 120	ESWA-180T04N3-R49P		
					575 / 120	ESWA-180T05N3-R49P		
75	100	200	250	200 - 310	240 / 120	ESWA-250T02N3-R50P	Q	Z3
					480 / 120	ESWA-250T04N3-R50P		
					575 / 120	ESWA-250T05N3-R50P		
100	125	250	300	275 - 420	240 / 120	ESWA-300T02N3-R51P	Q	Z3
					480 / 120	ESWA-300T04N3-R51P		
					575 / 120	ESWA-300T05N3-R51P		

Dimensions (inches)			
Box Size	Enclosure Size		
	H	W	D
D	20	16	8
O	30	20	10
P	44	24	10
Q	54	24	12

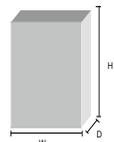

Notes:
 (1) Please contact your local WEG representative for starters with other control voltage.
 (2) 3-phase starters can be wired for single-phase applications



Data Worksheet and Request for Quote

Today's Date:

TSS		Need Quote By	
TAM		Requested Ship Date	

1. CUSTOMER INFO:

1.1 Company Name		1.3 Customer Phone/Fax	
1.2 Contact Name		1.4 End User Name	

2. SIZING:

2.1 Motor HP & RPM	
2.2 Motor FLA (Full Load Amps)	
2.3 Service Factor	

3. POWER & WIRING:

3.1 Single-Phase		3.2 Three-Phase	
3.3 Incoming Voltage [V]		3.4 Frequency [Hz]	
3.5 Portable Generator Power? YES or NO			

4. APPLICATION & ENVIRONMENT:

4.1 Replacing standard NEMA sizes? YES or NO. Specify current NEMA size									
4.2 Full Voltage		4.3 Wye-Delta		4.4 Part Winding		4.5 Non-Reversing		4.6 Reversing	
4.7 Specify Maximum number of Starts per hour									
4.8 Unit will be installed Indoors or Outdoors? Specify Ambient Temperature									
4.9 Open TYPE		4.10 Enclosed TYPE 1		4.11 Enclosed TYPE 4		4.12 Enclosed TYPE 4X			
4.13 Other Information									

5. SHORT CIRCUIT PROTECTION AND DISCONNECT:

5.1 None		5.2 Circuit Breaker		5.3 Non-Fusible Disconnect		5.4 Fusible Disconnect	
----------	--	---------------------	--	----------------------------	--	------------------------	--

6. CONTROL CIRCUIT:

6.1 Common control (same as power to motor)? YES or NO	
6.2 Control Circuit Transformer. Specify secondary voltage	
6.3 Transformer with extra capacity (VA)? Specify	

7. COVER MOUNTED 22mm DEVICES: (if yes, enter quantities)

7.1 Start/Stop Push Buttons		7.2 H-O-A Selector Switch		7.3 Off-On Selector Switch		7.4 Motor Run Light		7.5 Other (Specify)	
-----------------------------	--	---------------------------	--	----------------------------	--	---------------------	--	---------------------	--

8. OTHER SPECIFICATIONS:

WEG Electric Corporation

1-800-ASK-4-WEG

When completed, please contact your regional WEG sales specialist at 1-800-ASK-4-WEG (275-4934) for directions on submittal for quotation. Please complete as much as possible and then WEG can help you complete any further pertinent information to quote.

REV 08.10

Controls

Enclosed Combination Starters

Dimensions (in) - ESWA Series
 Type 4 / 12 - Metallic Enclosures

Size C

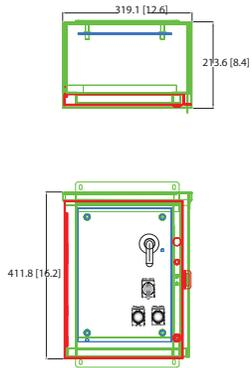

Size E

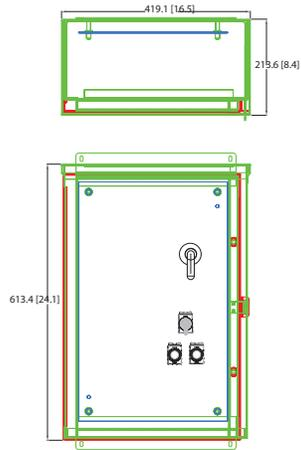

Size F

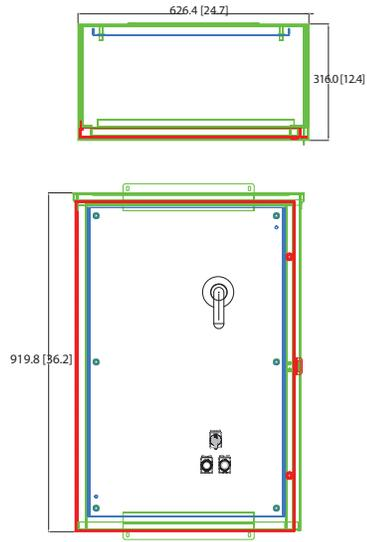

Size G

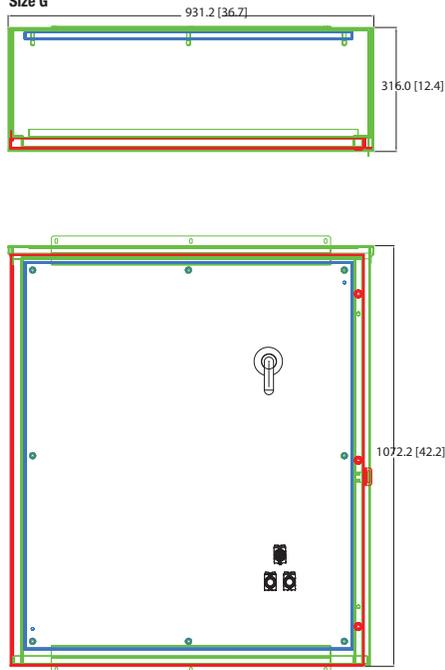

Size H

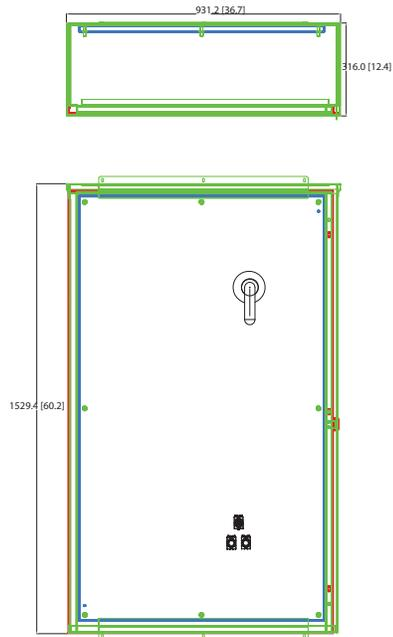

Controls Enclosed Combination Starters

Dimensions (in) - ESWC Series
Type 4 / 12 - Metallic Enclosure

Size C-1

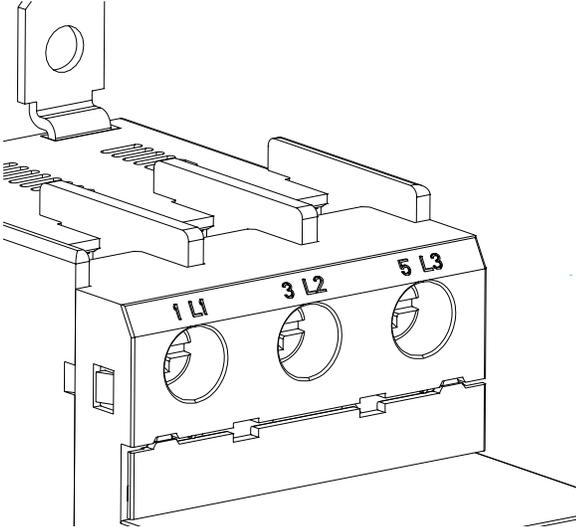

Size C-2

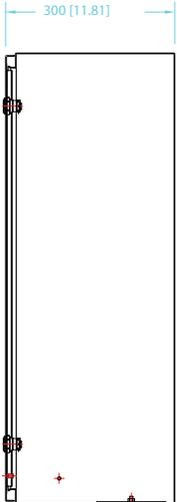
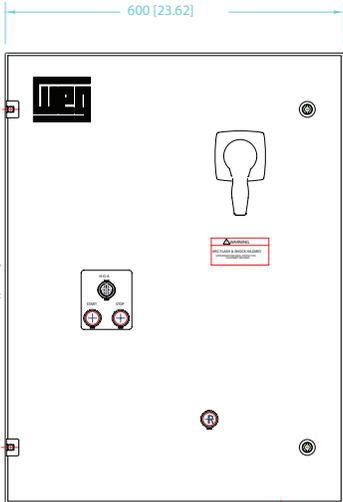

Size C-3

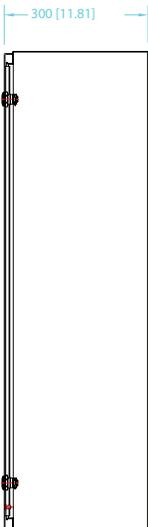
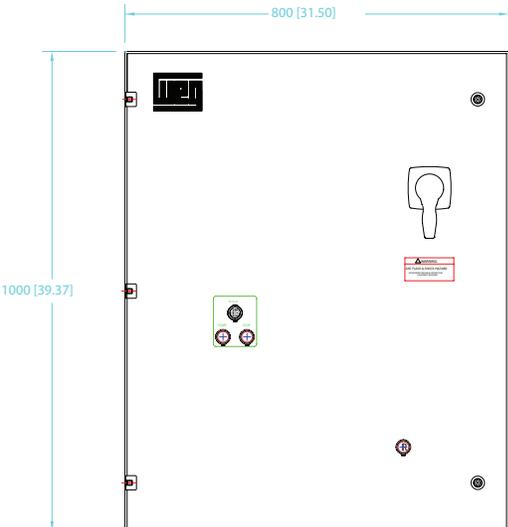



Controls Enclosed Combination Starters

Dimensions (in) – ESWF SERIES
Type 3R / 4 / 12 – Metallic Enclosure
Type 4X – Non-Metallic Enclosure

Size GX

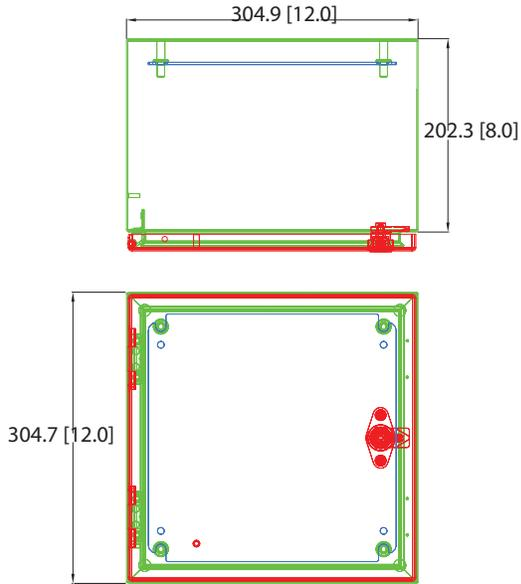

Size I

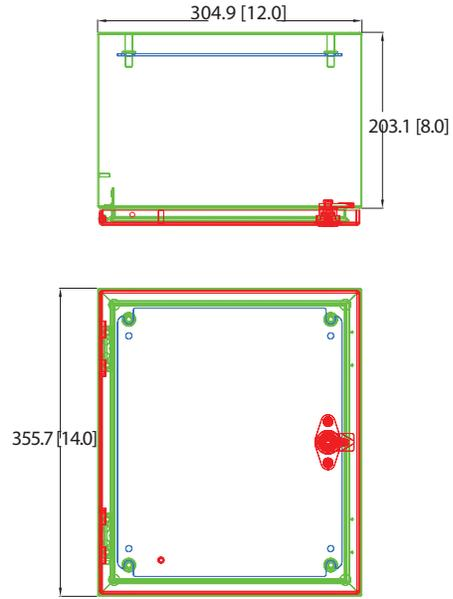

Size K

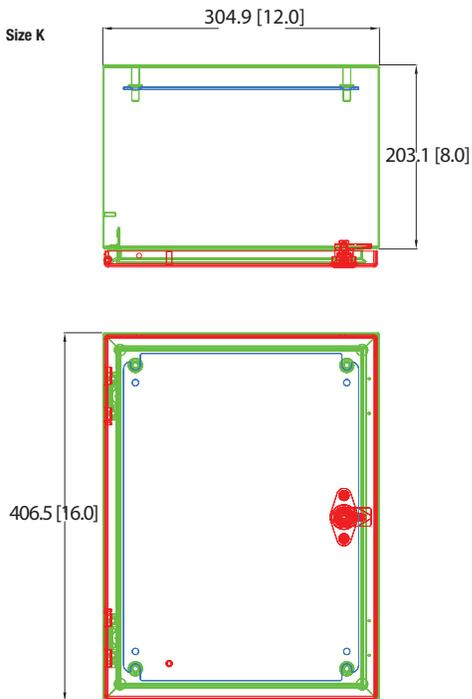

Size L

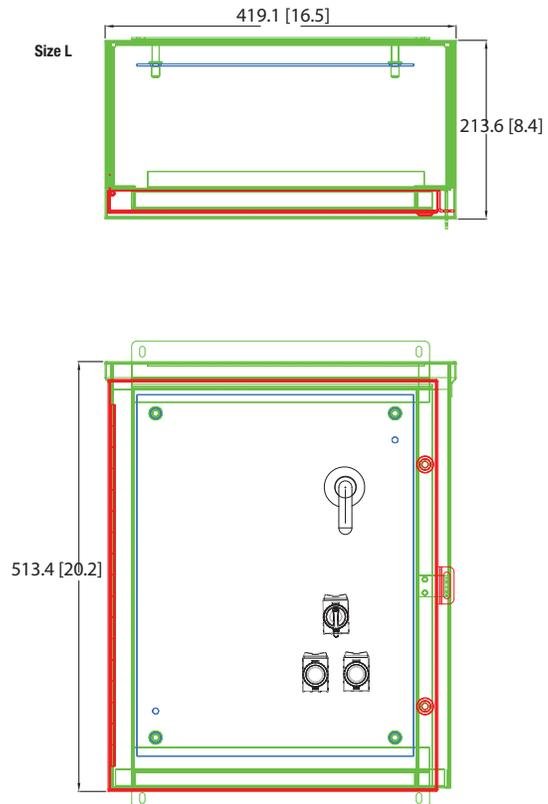

Controls

Enclosed Combination Starters

Dimensions (in) – ESWA Pump Controller SERIES
Type 3R – Metallic Enclosure

Size D

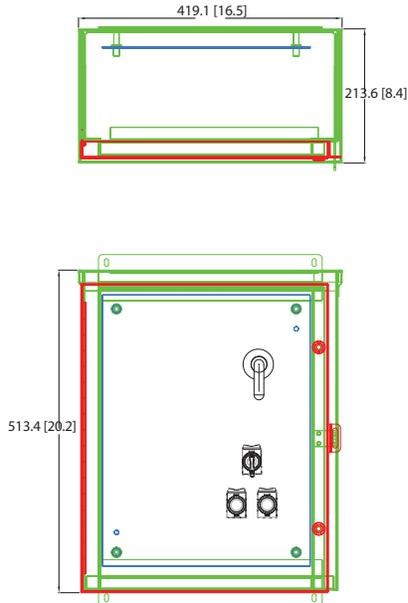

Size O

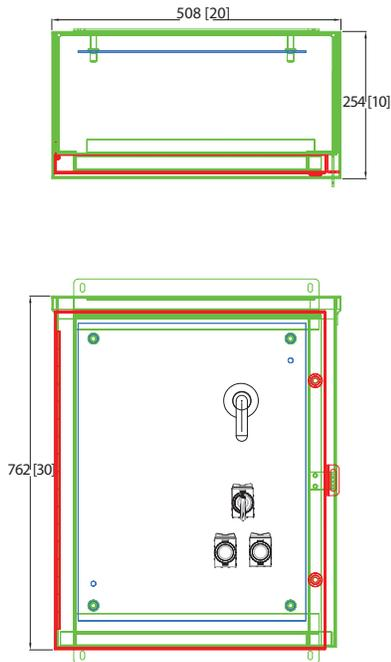

Size P

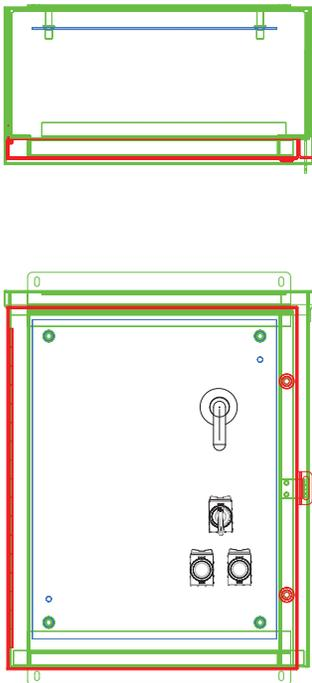

Size Q

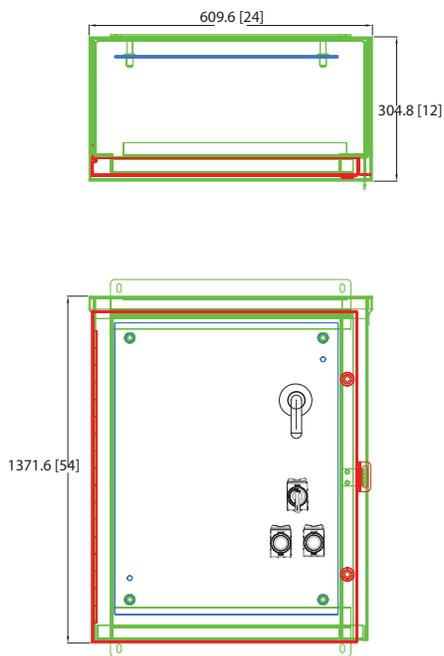



Controls Enclosed Combination Starters

Dimensions (in) – ESWF SERIES
Type 3R / 4 / 12 – Metallic Enclosure
Type 4X – Non-Metallic Enclosure

Size GX

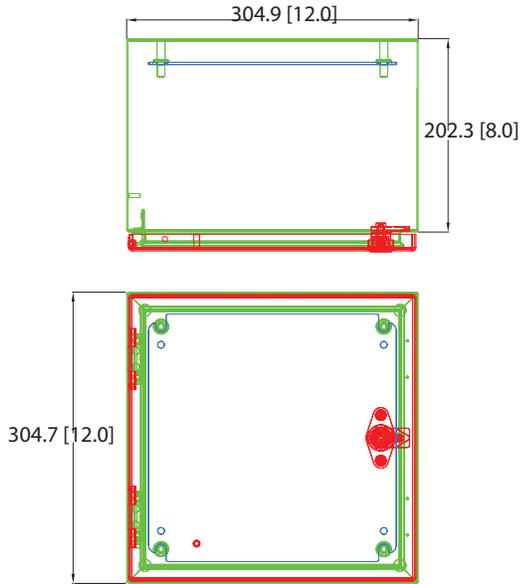

Size I

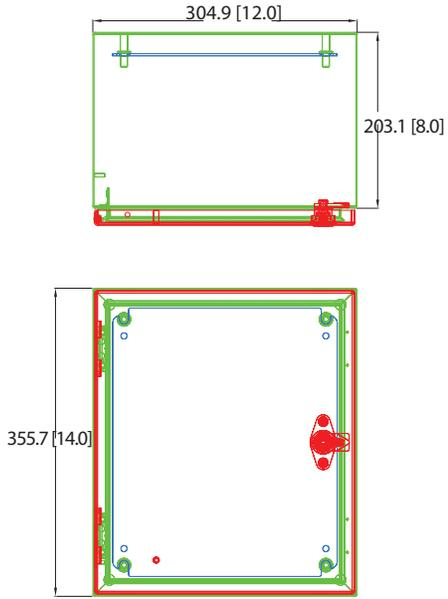

Size K

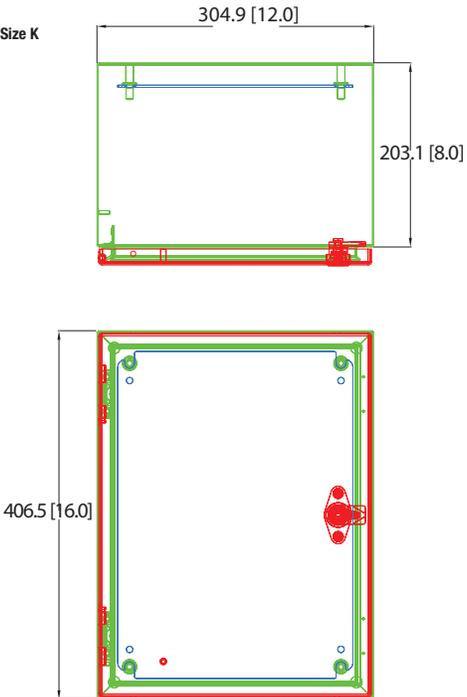

Size L

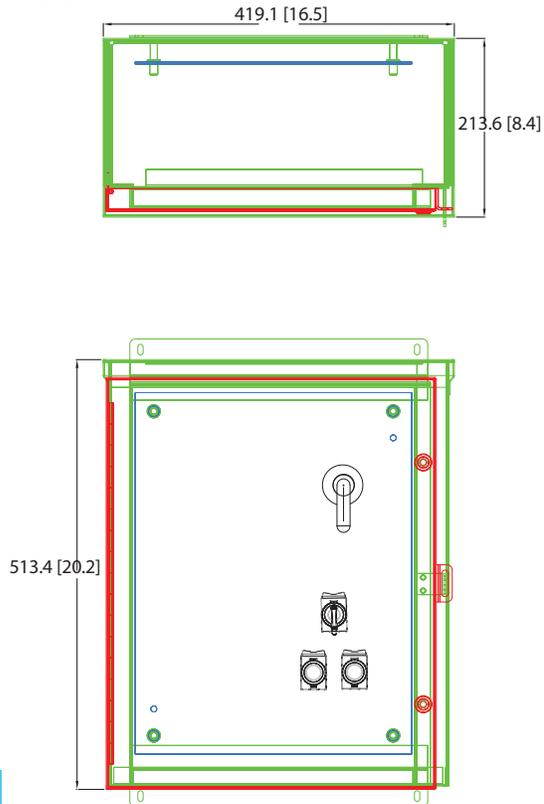

Controls

Enclosed Combination Starters

Dimensions (in) – ESWA Pump Controller SERIES
Type 3R – Metallic Enclosure

Size D

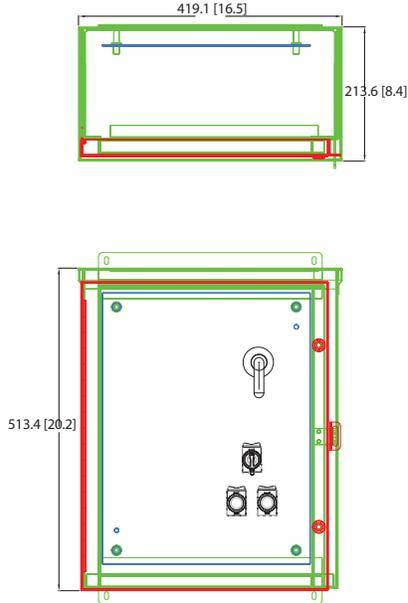

Size O

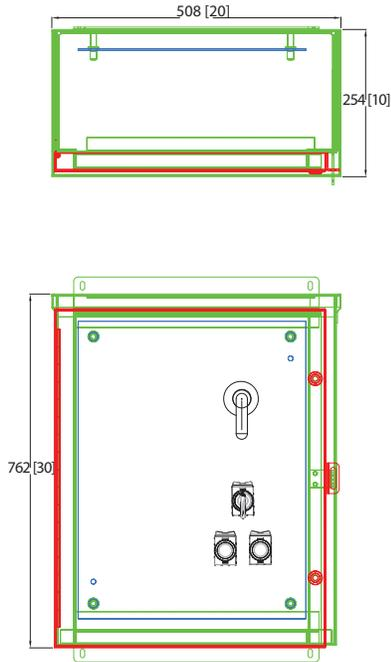

Size P

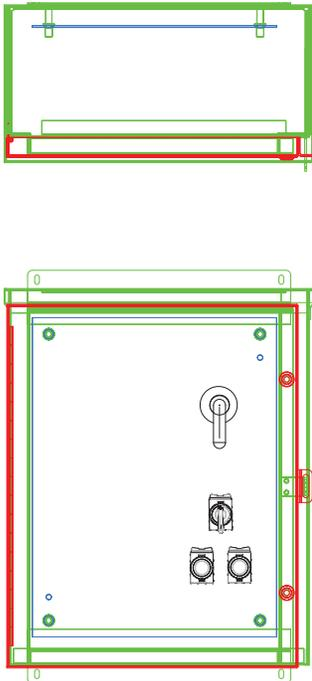

Size Q

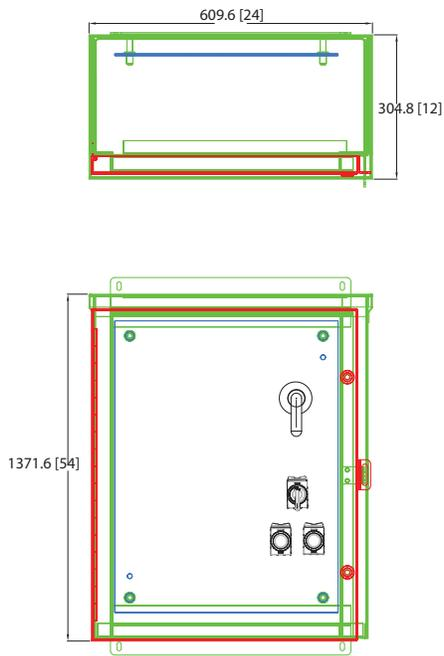

WEG Electric Corp. offers the following products, and more! With a full range of IEC/NEMA Global Certifications and a full line of products, WEG can supply the right solution for your needs anywhere in the world. To learn more about WEG's products and solutions or to locate a Distributor near you, please call **1-800-ASK-4WEG** or visit **www.weg.net/us**.

Low Voltage Motors,

Single and 3-Phase, 1/8 – 700HP

General Purpose Motors
Explosion Proof Motors
Crusher Duty Motors
IEC Tru-Metric Motors
Pump Motors including JP/JM
P-Base Pump Motors
Oil Well Pumping Motors
Pool & Spa Motors
Brake Motors
Compressor Duty Motors
Farm Duty Motors
Poultry Fan Motors
Auger Drive Motors
IEEE 841 Motors
Stainless Steel Wash Down Motors
Saw Arbor Motors
Cooling Tower Motors
Commercial HVAC Motors
Pad Mounted Motors
Vector Duty Motors

Large Electric Motors

Low Voltage 3-phase motors up to 2,500HP

Motors up to 70,000HP and 13,200V
Wound Rotor Systems (including starters) up to 70,000HP and 13,200V

Synchronous Motors up to 70,000HP and 13,200V

Explosion proof motors (Ex-d) up to 1,500kW and 11kV

Ex-n, Ex-e, Ex-p motors

Variable Frequency Drives

Low Voltage 1/4 to 2500HP, 230V – 480V
Medium Voltage 500-8000HP
Multi-pump systems
NEMA 4X
Dynamic braking resistors
Line and load reactors
Plug and play technology
Network communications: Profibus-DP, DeviceNet, Modbus-RTU

PLC functions integrated
Complete line of options and accessories

Soft Starters

3-1500HP
Oriented start-up
Built-in bypass contactor
Universal source voltage (230-575V, 50/60Hz)

Network communications: Profibus-DP, DeviceNet, Modbus-RTU

Complete Line of options and accessories
MV Soft-starter 3.3kV, 4.16kV: up to 3500HP, Withdrawable Power Stacks, & 8x PT100 Temperature monitoring

Controls

Mini – Contactors
IEC Contactors
Thermal Overload Relays
Manual Motor Protectors
Molded Case Circuit Breakers
Smart Relays
Enclosed Starters: combination & non-combination,

Pushbuttons & Pilot Lights
Timing & Motor Protection Relays
Terminal Blocks

Custom Panels

Custom configured to your specification.
NEMA 1, 12, 3R, 4 and 4X cabinets
Quick delivery of preconfigured drives and soft starters
UL 508 certified
Low Voltage (230-460)
Made in the U.S.A.

Generators

Brushless Synchronous Generators for diesel gen-sets up to 4,200kVA

Hydro-generators up to 25,000kVA
Turbo-generators up to 62,500kVA

Power Transformers

Built and engineered in North America
Voltages < 500kV
Ratings 5-300MVA
Station class, oil filled, round core, copper windings

Special configurations and designs available!

Ask your WEG Sales Representative for details.

Designed, built, and engineered to ANSI standards.

Custom Solution Package Sales

WEG can package any of its products for ease of sale! Enjoy a single point of contact for the entire package of products and assistance from quote through after-sales support. Ask your WEG Sales Representative for details.

Please contact your authorized distributor:



WEG Electric Corp.
6655 Sugarloaf Parkway
Duluth, GA 30097
Phone: 1-800-ASK-4WEG(275-4934)
web: www.weg.net